

CL-CM

UNIVERSAL Distributors G1/8 - G1/4

- UNIVERSAL Modular System: possibility to create a lot of different valves with a short number of basis elements
- Control: manual, mechanical, pneumatic, electric
- Traditional UNIVER spool system: fluctuating seals of special compound to reduce friction and prevent sticking
- High flow rate, high cycle life, suitable for vacuum application
- Modular sub-bases



TECHNICAL CHARACTERISTICS

Ambient temperature	-10 ÷ +45 °C	
Fluid temperature	max +50 °C	
Fluid	filtered air 50 µm not dehumidified, lubricated or not	
Commutation system	spool	
Ways/Positions	3/2 NC, 3/2 NO, 3/2 NC-NO, 5/2, 5/3	
Pressure	max 10 bar	
Control	indirect electro-pneumatic, pneumatic, manual, mechanical	
Return	pneumatic spring, mechanical spring	
Connections	G1/8	G1/4
Nominal Ø mm	6,5	8,5
Nominal flow rate (NI/min)	890	1480

CONSTRUCTIVE CHARACTERISTICS

Valve body	G1/8 = die-cast zamak
	G1/4 = aluminium
Seals	nitrile rubber
Actuators	technopolymer/aluminium
Spool	aluminium
Sub-base	zamak

ELECTRIC CHARACTERISTICS

Electropilot	U1
Coil	DA
Power consumption	3,5 W (DC) - 5 VA (AC)
Connector	AM 5110
Voltage	12 V DC - 24 V DC - 24 V AC - 110 V AC - 230 V AC
Manual override	with 2 positions screw

Flow rate characteristics

>> G1/8

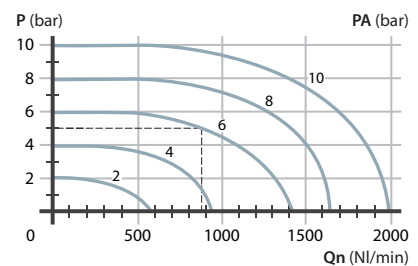

>> G1/4

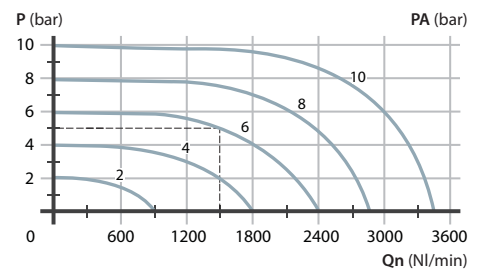

P = Working pressure
PA = Supply pressure
Qn = Flow rate

Modular system UNIVERSAL series

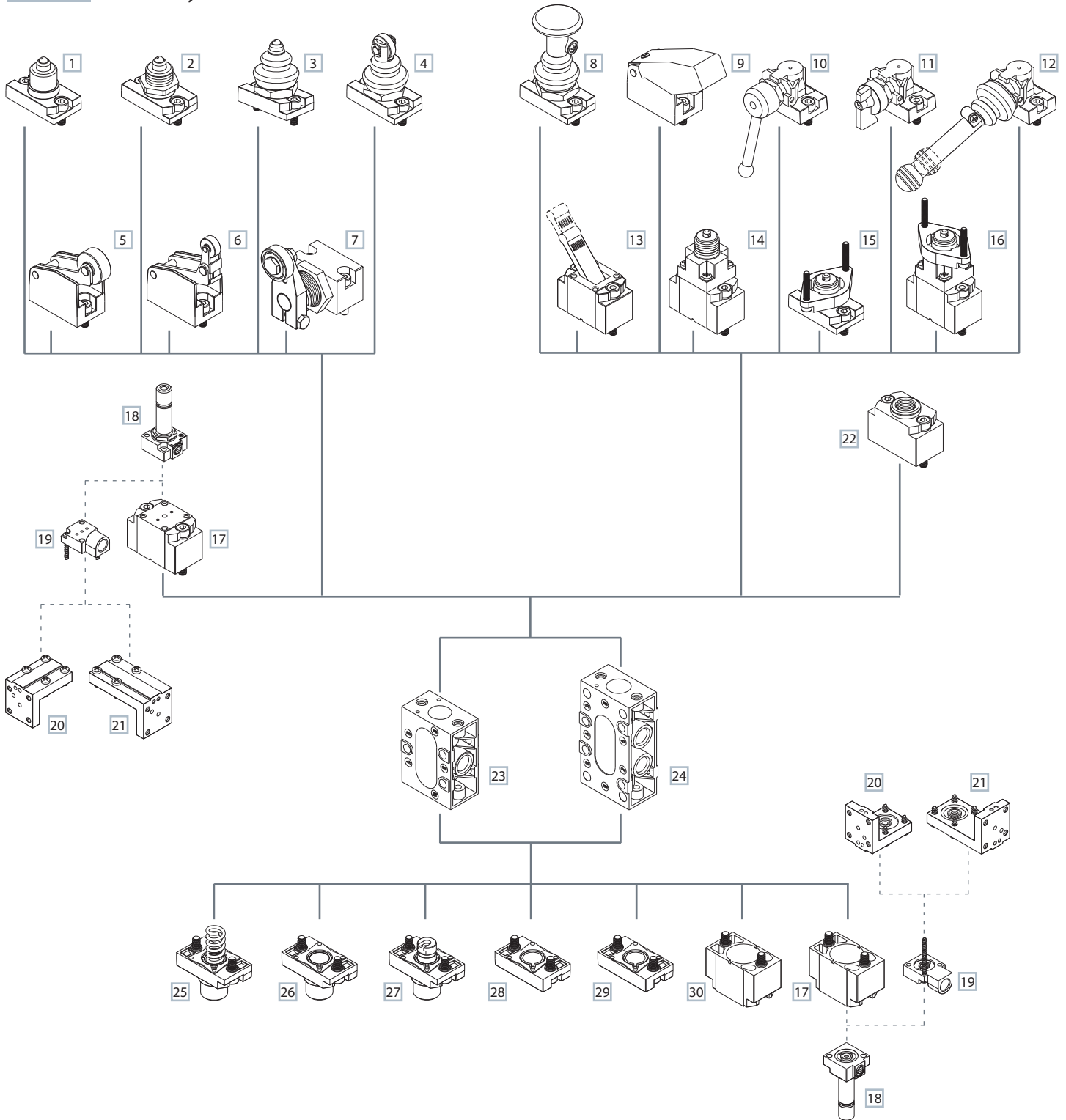

MECHANICAL CONTROL

- 1 Ball-push
- 2 Ball-push for screw panel mounting
- 3 Ball-push with dust protection
- 4 Roller with dust protection
- 5 Roller lever
- 6 Uni-directional roller lever
- 7 Bidirectional side roller lever

MANUAL CONTROL

- 8 Push-pull
- 9 Push
- 10 Rotating lever
- 11 Selector

- 12 90° short/long lever

- 13 Short/long lever
- 14 Threaded indirect operation
- 15 Direction operation for panel mounting
- 16 Indirect control for panel mounting

ELECTRIC CONTROL

- 17 Electric amplified
- 18 U1 electropilot
- 19 Plate for external servoassistance
- 20 "H" option angle plate
- 21 "P" option angle plate

PNEUMATIC CONTROL

- 22 Pneumatic amplified

BODY

- 23 3/2 body
- 24 5/2 body

RETURN

- 25 Mechanical spring
- 26 Pneumatic not amplified
- 27 2/3 positions plate
- 28 Bottom plate
- 29 Pneumatic spring
- 30 Pneumatic amplified

Modular system actuators/buttons

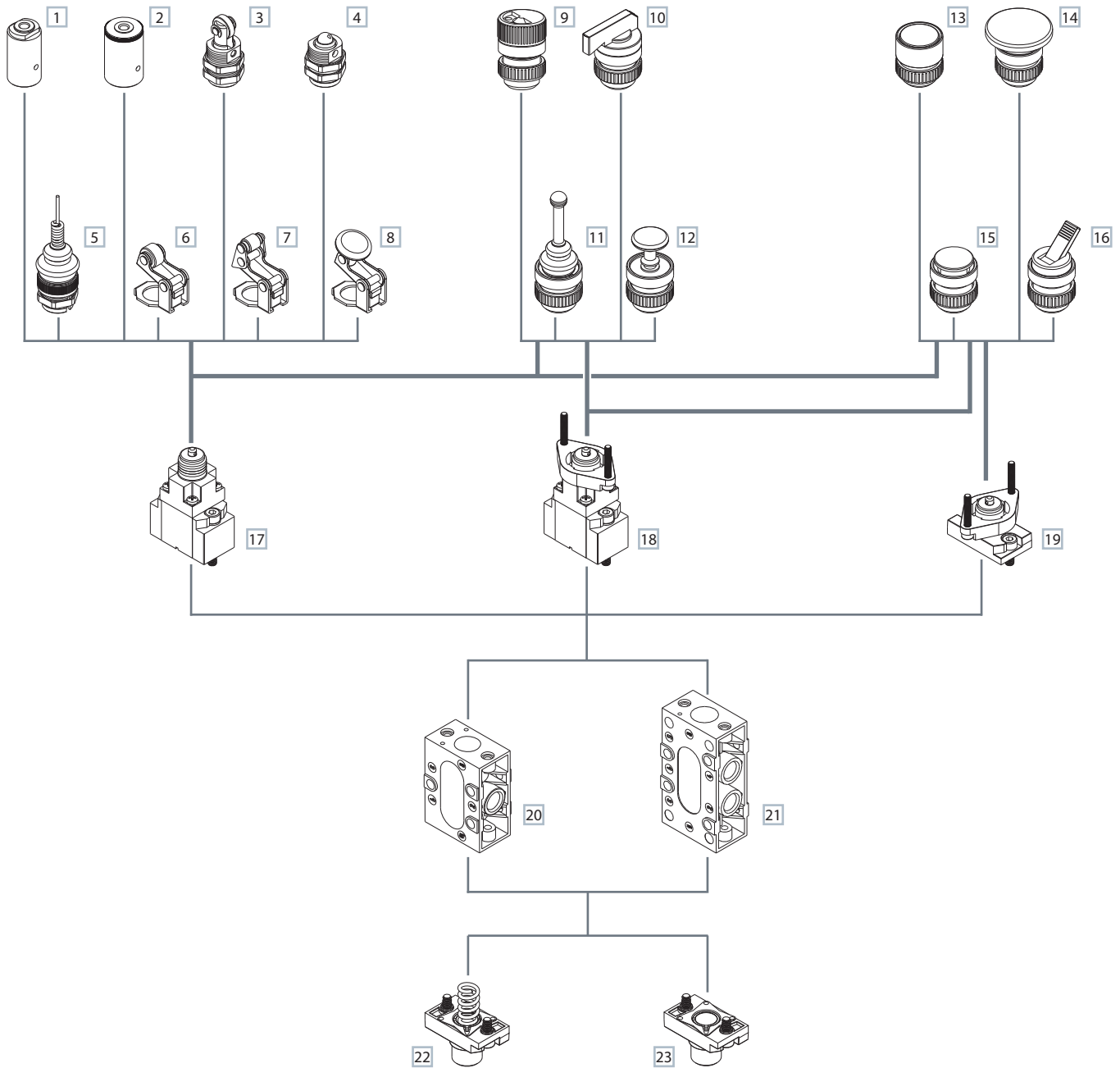

PNAUMATIC/MECHANICAL ACTUATORS

- 1 Pneumatic actuators
- 2 Pneumatic actuators amplified
- 3 Roller operator 1 position
- 4 Ball operator 1 position
- 5 Operator with omni-directional antenna 1 position
- 6 Roller lever operator 1 position
- 7 Articulated roller lever operator 1 position
- 8 Key operator 1 position

MANUAL PUSH

- 9 Rotating selector
- 10 Rotating lever selector
- 11 Omni-directional lever
- 12 Push pull actuators
- 13 Recessed button
- 14 Head button
- 15 Button
- 16 Lever operator

OVERRIDE

- 17 Threaded indirect operation
 - 18 Indirect operation for panel mounting
 - 19 Direct operation for panel mounting
- BODY**
- 22 3/2 Body
 - 24 5/2 Body
- RETURN**
- 20 Mechanical spring
 - 21 Pneumatic not amplified

G1/8 Valves with direct mechanical operation

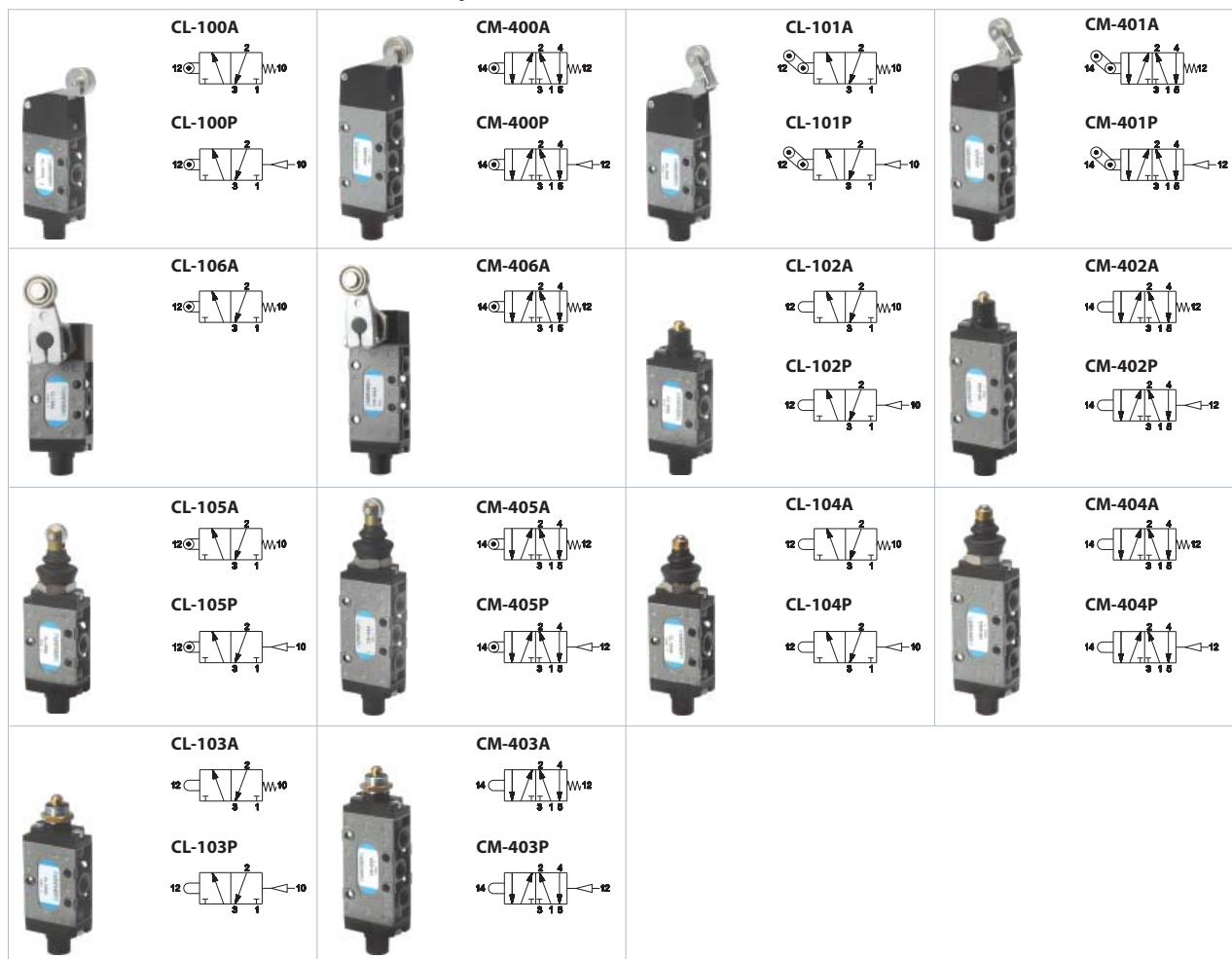

	Return	Flow rate (Nl/min)	Ø mm	Weight Kg	Force N	Part no.	Composition (a)			Tot L. mm
							Control	Body	Return	
ROLLER LEVER										
3/2 NC-NO	mechanical spring	890	6,5	0,21	23	CL-100A	A	1	H	112
	pneumatic not amplified	890	6,5	0,21	6	CL-100P	A	1	I	112
5/2	mechanical spring	890	6,5	0,25	23	CM-400A	A	2	H	129
	pneumatic not amplified	890	6,5	0,25	6	CM-400P	A	2	I	129
UNI-DIRECTIONAL ROLLER LEVER										
3/2 NC-NO	mechanical spring	890	6,5	0,22	18	CL-101A	B	1	H	123
	pneumatic not amplified	890	6,5	0,22	6	CL-101P	B	1	I	123
5/2	mechanical spring	890	6,5	0,26	18	CM-401A	B	2	H	139,5
	pneumatic not amplified	890	6,5	0,26	6	CM-401P	B	2	I	139,5
BIDIRECTIONAL SIDE ROLLER LEVER										
3/2 NC-NO	mechanical spring	890	6,5	0,30	25	CL-106A	C	1	H	118,5
5/2	mechanical spring	890	6,5	0,34	25	CM-406A	C	2	H	135
BALL-PUSH										
3/2 NC-NO	mechanical spring	890	6,5	0,19	64	CL-102A	D	1	H	97,7
	pneumatic not amplified	890	6,5	0,19	25	CL-102P	D	1	I	97,7
5/2	mechanical spring	890	6,5	0,23	64	CM-402A	D	2	H	114,2
	pneumatic not amplified	890	6,5	0,23	25	CM-402P	D	2	I	114,2
ROLLER WITH DUST PROTECTION										
3/2 NC-NO	mechanical spring	890	6,5	0,19	64	CL-105A	E	1	H	117
	pneumatic not amplified	890	6,5	0,18	25	CL-105P	E	1	I	117
5/2	mechanical spring	890	6,5	0,23	68	CM-405A	E	2	H	133,5
	pneumatic not amplified	890	6,5	0,22	26	CM-405P	E	2	I	133,5
BALL-PUSH WITH DUST PROTECTION										
3/2 NC-NO	mechanical spring	890	6,5	0,19	64	CL-104A	F	1	H	110
	pneumatic not amplified	890	6,5	0,18	25	CL-104P	F	1	I	110
5/2	mechanical spring	890	6,5	0,23	68	CM-404A	F	2	H	126,5
	pneumatic not amplified	890	6,5	0,22	26	CM-404P	F	2	I	126,5
BALL-PUSH FOR SCREW PANEL MOUNTING										
3/2 NC-NO	mechanical spring	890	6,5	0,19	64	CL-103A	G	1	H	97,7
	pneumatic not amplified	890	6,5	0,18	25	CL-103P	G	1	I	97,7
5/2	mechanical spring	890	6,5	0,23	68	CM-403A	G	2	H	114,2
	pneumatic not amplified	890	6,5	0,22	25	CM-403P	G	2	I	114,2

To get 3/2 NO version, supply the valve from port 3
Pressure 0 ÷ 10 bar for all part numbers

(a) = see page 3_7

Composition

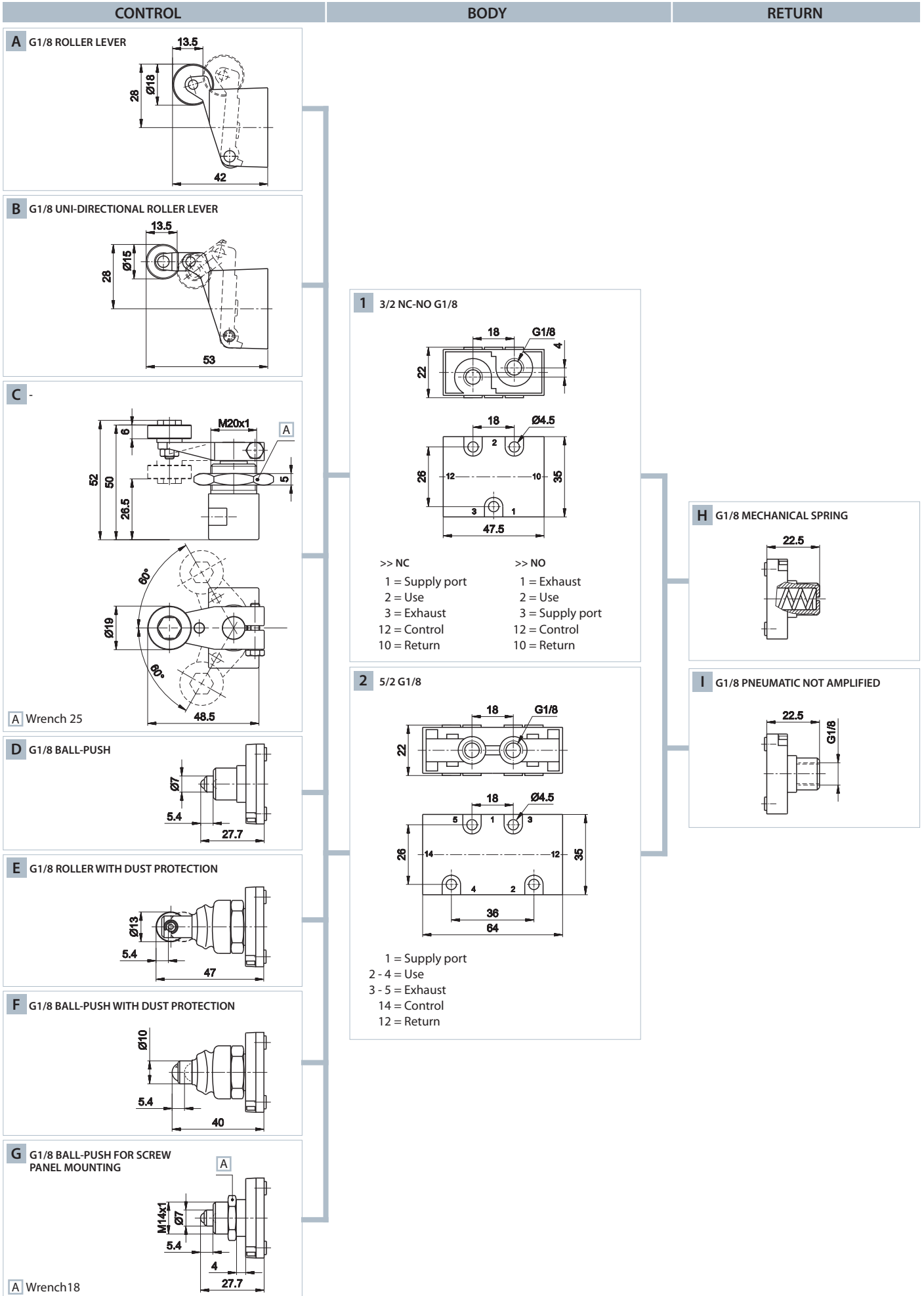

G1/4 Valves with direct mechanical operation

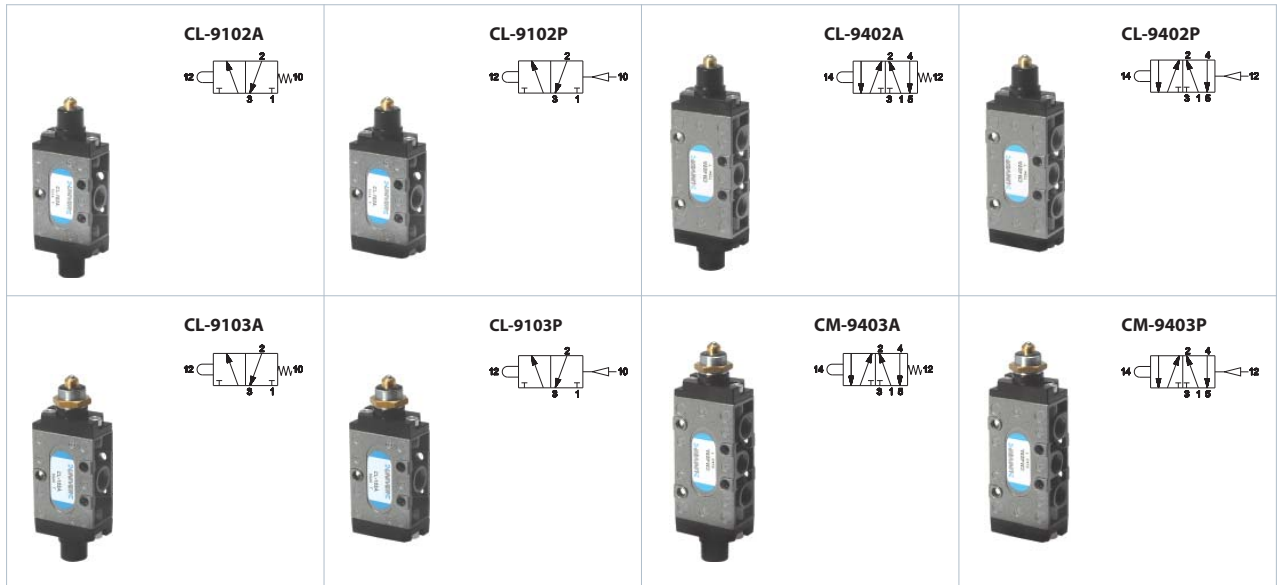

	Return	Flow rate (NI/min)	Ø mm	Weight Kg	Force N	Part no.	Composition (a)			Tot L. mm
							Control	Body	Return	
BALL-PUSH										
3/2 NC-NO	mechanical spring	1480	8,5	0,26	68	CL-9102A	D	1	H	117
	pneumatic not amplified	1480	8,5	0,26	26	CL-9102P	D	1	I	106
5/2	mechanical spring	1480	8,5	0,28	68	CM-9402A	D	2	H	134,5
	pneumatic not amplified	1480	8,5	0,28	26	CM-9402P	D	2	I	123,5
BALL-PUSH FOR SCREW PANEL MOUNTING										
3/2 NC-NO	mechanical spring	1480	8,5	0,26	68	CL-9103A	G	1	H	117
	pneumatic not amplified	1480	8,5	0,24	26	CL-9103P	G	1	I	106
5/2	mechanical spring	1480	6,5	0,28	64	CM-9403A	G	2	H	134,5
	pneumatic not amplified	1480	6,5	0,26	26	CM-9403P	G	2	I	123,5

To get 3/2 NO version, supply the valve from port 3
 Pressure 0 ÷ 10 bar for all part numbers

(a) = see page 3_9

Composition

CONTROL

BODY

RETURN

D G1/4 BALL-PUSH

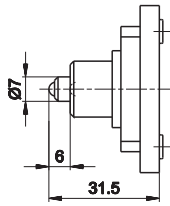

G G1/4 BALL-PUSH FOR SCREW PANEL MOUNTING

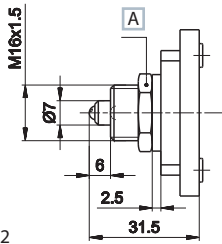

A Wrench 22

1 3/2 NC-NO G1/4

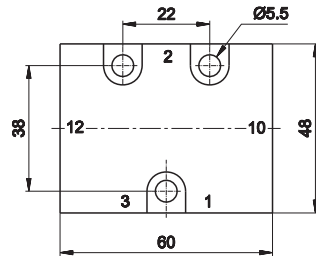
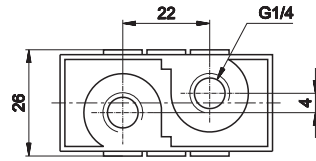

- | | |
|-----------------|-----------------|
| >> NC | >> NO |
| 1 = Supply port | 1 = Exhaust |
| 2 = Use | 2 = Use |
| 3 = Exhaust | 3 = Supply port |
| 12 = Control | 12 = Control |
| 10 = Return | 10 = Return |

H G1/4 MECHANICAL SPRING

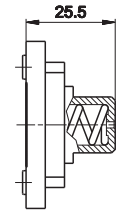

I G1/4 PNEUMATIC SPRING

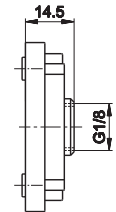

2 5/2 G1/4

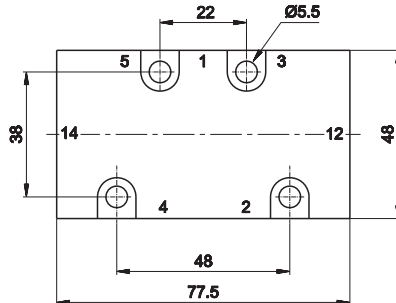
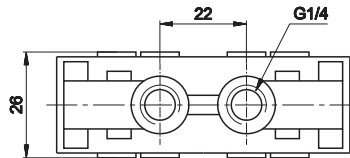

- 1 = Supply port
- 2 - 4 = Use
- 3 - 5 = Exhaust
- 14 = Control
- 12 = Return

G1/8 - G1/4 Valves with direct mechanical operator for pneumatic and mechanical actuators

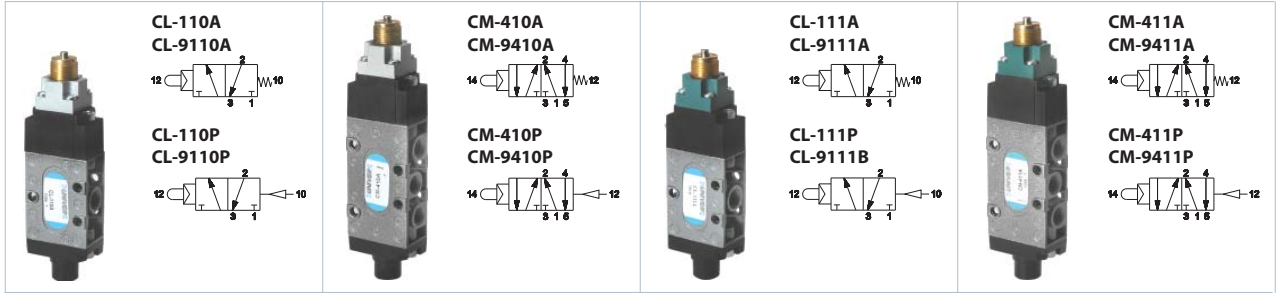

	Thread	Return	Pressure bar	Flow rate (NI/min)	Ø mm	Weight Kg	Force N	Part no.
BALL-PUSH								
3/2 NC	G1/8	mechanical spring	2,5÷10	890	6,5	0,19	11	CL-110A
	G1/8	pneumatic not amplified	1÷10	890	6,5	0,18	11	CL-110P
	G1/4	mechanical spring	2÷10	1480	8,5	0,26	11	CL-9110A
	G1/4	pneumatic not amplified	1÷10	1480	8,5	0,24	11	CL-9110P
5/2	G1/8	mechanical spring	3÷10	890	6,5	0,23	11	CM-410A
	G1/8	pneumatic not amplified	1,2÷10	890	6,5	0,22	11	CM-410P
	G1/4	mechanical spring	2÷10	1480	8,5	0,28	11	CM-9410A
	G1/4	pneumatic not amplified	1,2÷10	1480	8,5	0,26	11	CM-9410P
SENSITIVE BALL-PUSH								
3/2 NC	G1/8	mechanical spring	2,5÷10	890	6,5	0,19	3	CL-111A
	G1/8	pneumatic not amplified	1÷10	890	6,5	0,18	3	CL-111P
	G1/4	mechanical spring	2÷10	1480	8,5	0,26	3	CL-9111A
	G1/4	pneumatic not amplified	1÷10	1480	8,5	0,24	3	CL-9111P
5/2	G1/8	mechanical spring	3÷10	890	6,5	0,23	3	CM-411A
	G1/8	pneumatic not amplified	1,2÷10	890	6,5	0,22	3	CM-411P
	G1/4	mechanical spring	2÷10	1480	8,5	0,28	3	CM-9411A
	G1/4	pneumatic not amplified	1,2÷10	1480	8,5	0,26	3	CM-9411P

3/2 NC G1/8 - G1/4

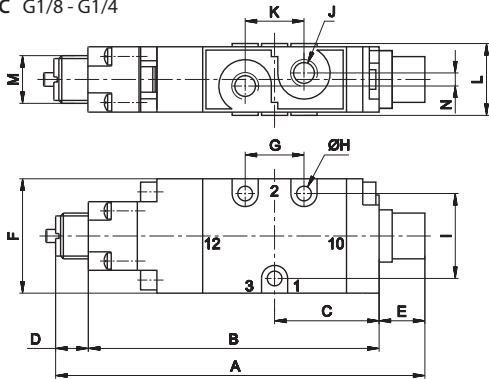

1 = Supply port
2 = Use
3 = Exhaust
12 = Control
10 = Return

	A	B	C	D	E	F	G	H	I	J	K	L	M	N
G1/8	116	92	32	10	14	35	22	4,5	26	G1/8	22	22	M14x1	4
G1/4	136,5	112	41	10	14,5	48	18	5,5	38	G1/4	18	26	M14x1	4



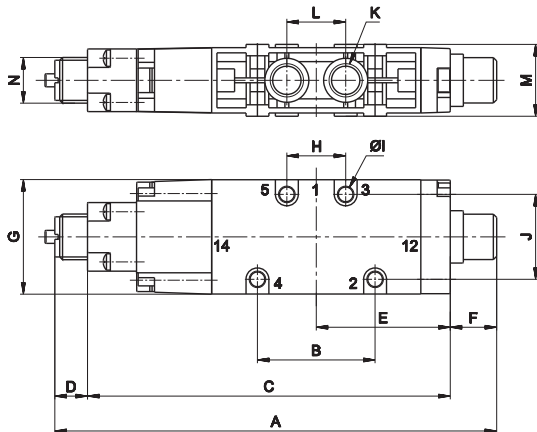





























5/2 G1/8 - G1/4



1 = Supply port
2 - 4 = Use
3 - 5 = Exhaust
14 = Control
12 = Return

	A	B	C	D	E	F	G	H	I	J	K	L	M	N
G1/8	135	36	111	10	41	14	35	18	4,5	26	G1/8	18	22	M14x1
G1/4	154	48	129,5	10	49,7	14,5	48	22	5,5	38	G1/4	22	26	M14x1

G1/8 - G1/4 Valves with direct mechanical operator for pneumatic and mechanical actuators

PNEUMATIC AND MECHANICAL ACTUATORS			MANUAL ACTUATORS		
	Pneumatic operator	AI-3550 		Recessed button ■ BLACK AI-3511 ■ RED AI-3512 ■ GREEN AI-3513 	
	Amplified pneumatic operator	AI-3551 		Head button ■ RED AI-3514 ■ BLACK AI-3516 ■ RED AI-3514D ■ BLACK AI-3516D 	
	Roller operator 1 position	AI-3560 		Button ■ GREEN AI-3515 ■ RED AI-3517 ■ BLACK AI-3519 	
	Ball-push operator 1 position	AI-3562 		Accident prevention rotating selector ■ BLACK AI-3520 ■ BLACK AI-3521 	
	Operator with omni-directional antenna 1 position	AI-3563 		Rotating lever selector ■ BLACK AI-3522 ■ BLACK AI-3523 	
	Roller lever operator 1 position	AI-3570 		Lever operator ■ BLACK AI-3524 	
	Articulated roller operator 1 position Complete actuation with stroke 2,5 mm, max stroke 4,7 mm	AI-3571 		Omni-directional operator ■ BLACK AI-3525 	
	Key operator 1 position	AI-3572 		Push-pull operator ■ BLACK AI-3526 	

For actuators dimensions see section "Accessories>Actuators"

G1/8 Valves with direct operator for panel mounting actuators

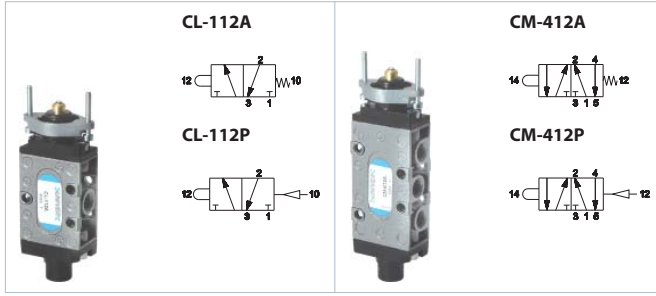

Return	Pressure bar	Flow rate (NI/min)	Ø mm	Weight Kg	Force N	Part no.
BALL-PUSH						
3/2 NC-NO mechanical spring	0÷10	890	6,5	0,19	64	CL-112A
3/2 NC-NO pneumatic not amplified	0÷10	890	6,5	0,18	25	CL-112P
5/2 mechanical spring	0÷10	890	6,5	0,23	64	CM-412A
5/2 pneumatic not amplified	0÷10	890	6,5	0,22	25	CM-412P

To get 3/2 NO version supply the valve from port 3

	Recessed button	<ul style="list-style-type: none"> ■ YELLOW AI-3511Q ■ RED AI-3512Q ■ GREEN AI-3513Q 	
	Head button	<ul style="list-style-type: none"> ■ RED AI-3514Q ■ BLACK AI-3516Q 	
	Button	<ul style="list-style-type: none"> ■ GREEN AI-3515Q ■ RED AI-3517Q ■ BLACK AI-3519Q 	
	Lever operator	<ul style="list-style-type: none"> ■ BLACK AI-3524Q 	

3/2 NC-NO G1/8

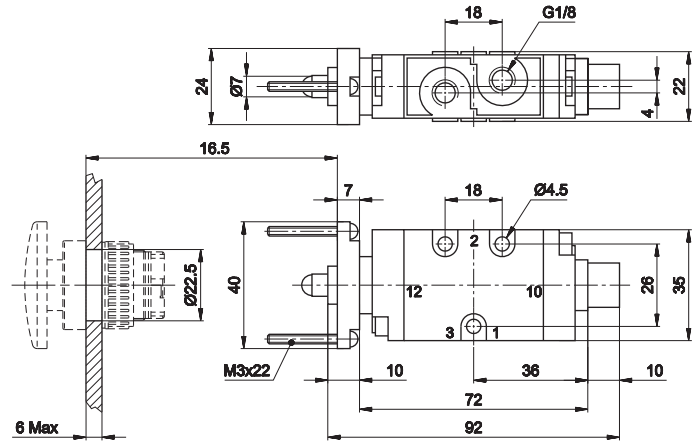

>> NC

- 1 = Supply port
- 2 = Use
- 3 = Exhaust
- 12 = Control
- 10 = Return

>> NO

- 1 = Exhaust
- 2 = Use
- 3 = Supply port
- 12 = Control
- 10 = Return

5/2 G1/8

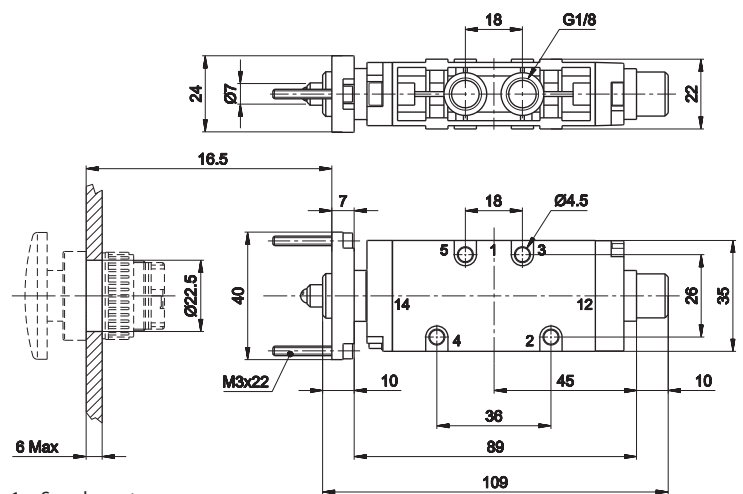

- 1 = Supply port
- 2 - 4 = Use
- 3 - 5 = Exhaust
- 14 = Control
- 12 = Return

For actuator dimensions see section "Accessories>Buttons"

G1/8 - G1/4 Valves with indirect operator for panel mounting actuators

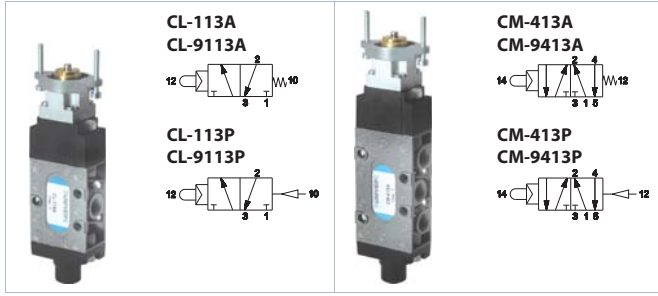

	Thread	Return	Pressione bar	Flow rate (NI/min)	Ø mm	Weight Kg	Force N	Part no.
3/2 NC	BALL-PUSH							
	G1/8	mechanical spring	2,5÷10	890	6,5	0,20	11	CL-113A
	G1/8	pneumatic non amplified	1÷10	890	6,5	0,19	11	CL-113P
	G1/4	mechanical spring	2÷10	1480	8,5	0,27	11	CL-9113A
	G1/4	pneumatic non amplified	1÷10	1480	8,5	0,26	11	CL-9113P
5/2	G1/8	mechanical spring	3÷10	890	6,5	0,24	11	CM-413A
	G1/8	pneumatic non amplified	1,2÷10	890	6,5	0,23	11	CM-413P
	G1/4	mechanical spring	2÷10	1480	6,5	0,29	11	CM-9413A
	G1/4	pneumatic non amplified	1,2÷10	1480	6,5	0,28	11	CM-9413P

	Recessed button	<ul style="list-style-type: none"> BLACK AI-3511Q RED AI-3512Q GREEN AI-3513Q 	
	Head button	<ul style="list-style-type: none"> RED AI-3514Q BLACK AI-3516Q RED AI-3514QD BLACK AI-3516QD 	
	Button	<ul style="list-style-type: none"> GREEN AI-3515Q RED AI-3517Q BLACK AI-3519Q 	
	Accident prevention rotating selector	<ul style="list-style-type: none"> BLACK AI-3520Q BLACK AI-3521Q 	
	Lever operator	<ul style="list-style-type: none"> BLACK AI-3524Q 	
	Rotating lever selector	<ul style="list-style-type: none"> BLACK AI-3523Q BLACK AI-3522Q 	
	Omni-directional lever	<ul style="list-style-type: none"> BLACK AI-3525Q 	
	Push-pull operator	<ul style="list-style-type: none"> BLACK AI-3526Q 	

3/2 NC G1/8 - G1/4

1 = Supply port
2 = Use
3 = Exhaust
12 = Control
10 = Return

	A	B	C	D	E	F	G	H	I	J	K	L	M	N	O	P	Q
G1/8	116	92	32	10	14	35	18	4,5	26	7	40	G1/8	18	22	24	M14X1	4
G1/4	136,5	112	41	10	14,5	48	22	5,5	38	7	40	G1/4	22	26	24	M14X1	4

5/2 G1/8 - G1/4

1 = Supply port
2 - 4 = Use
3 - 5 = Exhaust
14 = Control
12 = Return

	A	B	C	D	E	F	G	H	I	J	K	L	M	N	O	P	Q
G1/8	135	36	111	10	41	14	35	18	4,5	22	7	40	G1/8	18	22	24	M14X1
G1/4	154	48	129,5	10	49,7	14,5	48	22	5,5	26	7	40	G1/4	22	26	24	M14X1

For actuator dimensions see section "Accessories>Buttons"

G1/8 Manually operated valves

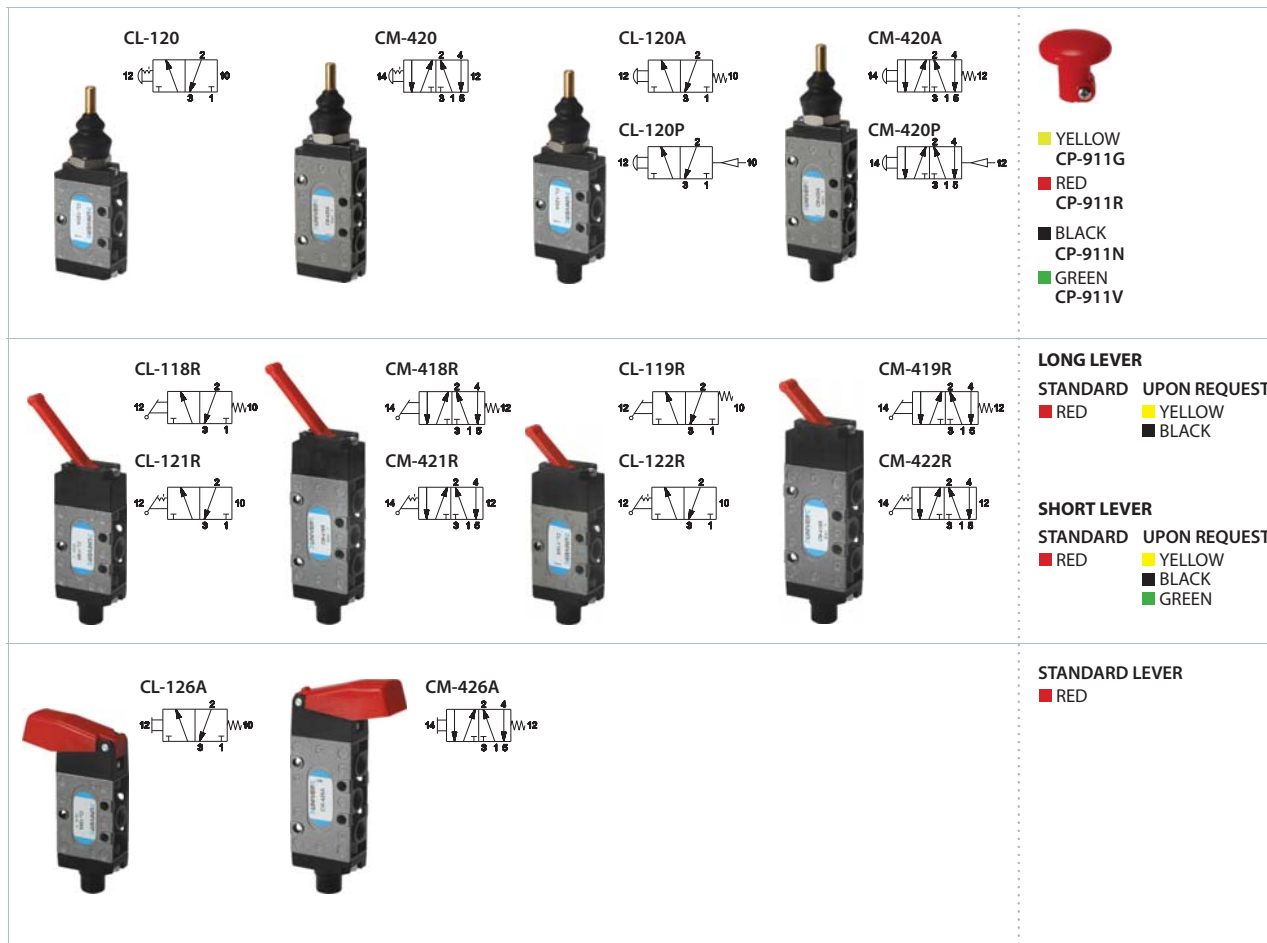

Return	Flow rate (Nl/min)	Ø mm	Weight Kg	Force N	Part no.	Composition (a)			Tot L. mm	
						Control	Body	Return		
PUSH-PULL (b)										
3/2 NC-NO	push-pull	890	6,5	0,19	25	CL-120	A	1	H	108,5
5/2	push-pull	890	6,5	0,22	25	CM-420	A	2	H	125
3/2 NC-NO	mechanical spring	890	6,5	0,19	25	CL-120A	A	1	F	121
5/2	mechanical spring	890	6,5	0,22	25	CM-420A	A	2	F	137,5
3/2 NC-NO	pneumatic not amplified	890	6,5	0,18	25	CL-120P	A	1	I	121
5/2	pneumatic not amplified	890	6,5	0,21	25	CM-420P	A	2	I	137,5
BUTTON										
3/2 NC-NO	mechanical spring	890	6,5	0,20	15	CL-126A	B	1	F	100
5/2	mechanical spring	890	6,5	0,23	15	CM-426A	B	2	F	116,5
LONG LEVER (STANDARD RED COLOUR)										
3/2 NC-NO	mechanical spring	890	6,5	0,17	10	CL-118R	C	1	F	126
5/2	mechanical spring	890	6,5	0,21	10	CM-418R	C	2	F	142,5
3/2 NC-NO	lever	890	6,5	0,16	10	CL-121R	C	1	G	126
5/2	lever	890	6,5	0,20	10	CM-421R	C	2	G	142,5
SHORT LEVER (STANDARD RED COLOUR)										
3/2 NC-NO	mechanical spring	890	6,5	0,17	20	CL-119R	C	1	F	112
5/2	mechanical spring	890	6,5	0,21	20	CM-419R	C	2	F	128,5
3/2 NC-NO	lever	890	6,5	0,16	20	CL-122R	C	1	G	112
5/2	lever	890	6,5	0,20	20	CM-422R	C	2	G	128,5

To get 3/2 NO version, supply the valve from port 3

(b) = valves are supplied without operator Pressure 0 ÷ 10 bar for all part numbers

(a) = see pages 3_18

Overall dimensions include operator

G1/8 Manually operated valves

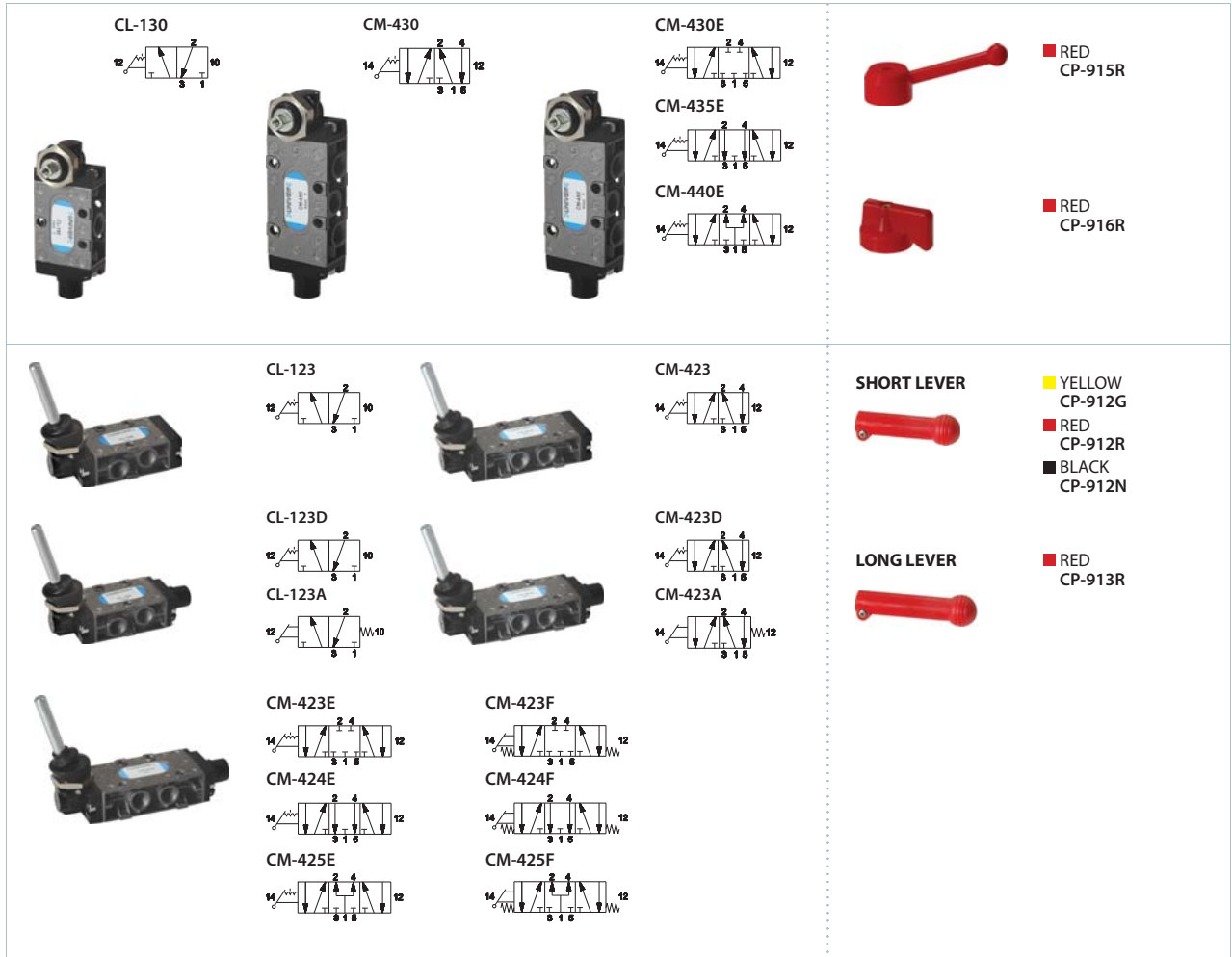

	Return	Flow rate (NI/min)	Ø mm	Weight Kg	Force N	Part no.	Composition (a)			Tot L. mm
							Control	Body	Return	
ROTATING LEVER (SELECTOR UPON REQUEST) (b)										
3/2 NC-NO	rotating lever	890	6,5	0,22	27	CL-130	D	1	G	97
5/2	rotating lever	890	6,5	0,25	27	CM-430	D	2	G	113,5
5/3 c.c.	rotating lever	890	6,5	0,25	27	CM-430E	D	2	G	113,5
5/3 o.c.	rotating lever	890	6,5	0,24	27	CM-435E	D	2	G	113,5
5/3 p.c.	rotating lever	890	6,5	0,24	27	CM-440E	D	2	G	113,5
90° LEVER - 3 POSITION (b)										
3/2 NC-NO	lever	890	6,5	0,17	2,5÷4	CL-123	E	1	H	79,5
5/2	lever	890	6,5	0,23	2,5÷4	CM-423	E	2	H	96
3/2 NC-NO	lever	890	6,5	0,17	3,5÷5	CL-123D	E	1	G	92
5/2	lever	890	6,5	0,23	3,5÷5	CM-423D	E	2	G	108,5
3/2 NC-NO	mechanical spring	890	6,5	0,18	9÷13	CL-123A	E	1	F	92
5/2	mechanical spring	890	6,5	0,23	9÷13	CM-423A	E	2	F	108,5
5/3 c.c.	lever	890	6,5	0,23	3,5÷5	CM-423E	E	2	G	108,5
	lever	890	6,5	0,23	6,5÷10	CM-423F	E	2	G	108,5
5/3 o.c.	lever	890	6,5	0,23	3,5÷3	CM-424E	E	2	G	108,5
	lever	890	6,5	0,23	6,5÷10	CM-424F	E	2	G	108,5
5/3 p.c.	lever	890	6,5	0,23	7,5÷5	CM-425E	E	2	G	108,5
	lever	890	6,5	0,23	6,5÷10	CM-425F	E	2	G	108,5

o.c. = open centres c.c. = closed centres p.c. = pressurized centres

To get 3/2 NO version, supply the valve from port 3

(b) = valves are supplied without operator Pressure 0 ÷ 10 bar for all part numbers

(a) = see pages 3_18

Overall dimensions include operator

G1/4 Manually operated valves

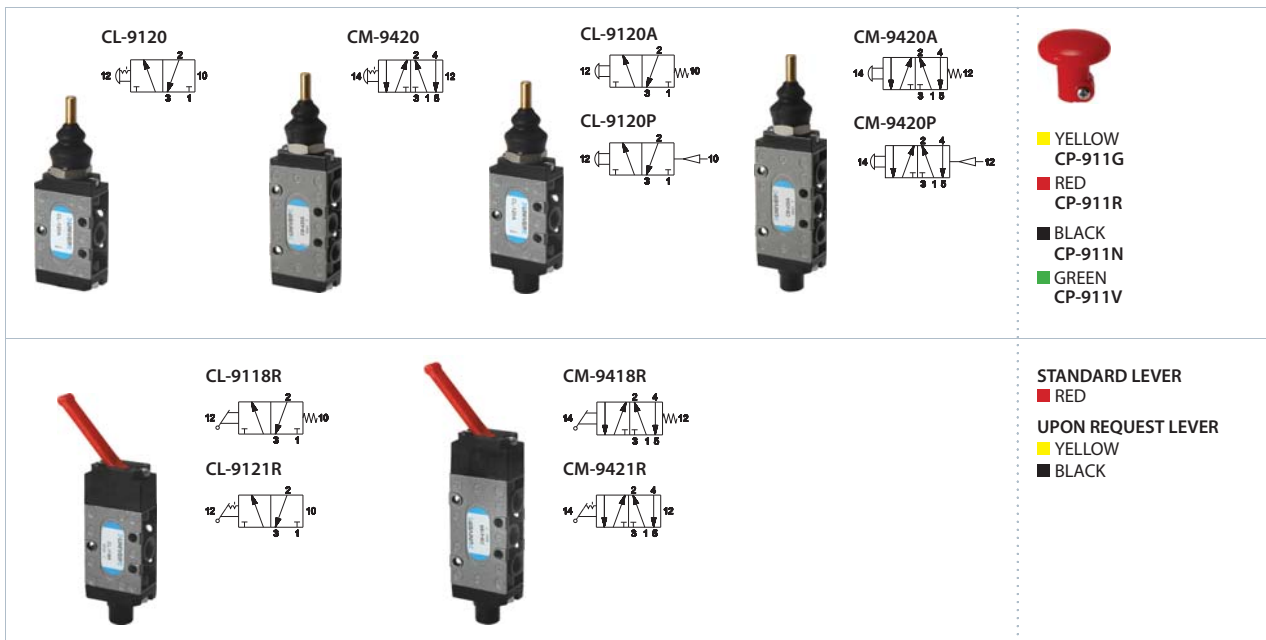

Return	Flow rate (NI/min)	Ø mm	Weight Kg	Force N	Part no.	Composition (a)			Tot L. mm	
						Control	Body	Return		
PUSH-PULL^(b)										
3/2 NC-NO	push-pull	1480	8,5	0,26	26	CL-9120	A	1	H	127
5/2	push-pull	1480	8,5	0,26	26	CM-9420	A	2	H	144,5
3/2 NC-NO	mechanical spring	1480	8,5	0,26	26	CL-9120A	A	1	F	138
5/2	mechanical spring	1480	8,5	0,26	26	CM-9420A	A	2	F	155,5
3/2 NC-NO	pneumatic not amplified	1480	8,5	0,24	26	CL-9120P	A	1	I	127
5/2	pneumatic not amplified	1480	8,5	0,24	26	CM-9420P	A	2	I	144,5
LONG LEVER (standard red colour)										
3/2 NC-NO	mechanical spring	1480	8,5	0,23	11	CL-9118R	C	1	F	144
5/2	mechanical spring	1480	8,5	0,25	11	CM-9418R	C	2	F	161,5
3/2 NC-NO	lever	1480	8,5	0,22	11	CL-9121R	C	1	G	144
5/2	lever	1480	8,5	0,24	11	CM-9421R	C	2	G	161,5

To get 3/2 NO version, supply the valve from port 3
 (b) = valves are supplied without operator Pressure 0 ÷ 10 bar for all part numbers

(a) = see pages 3_18
 Overall dimensions include operator

G1/4 Manually operated valves

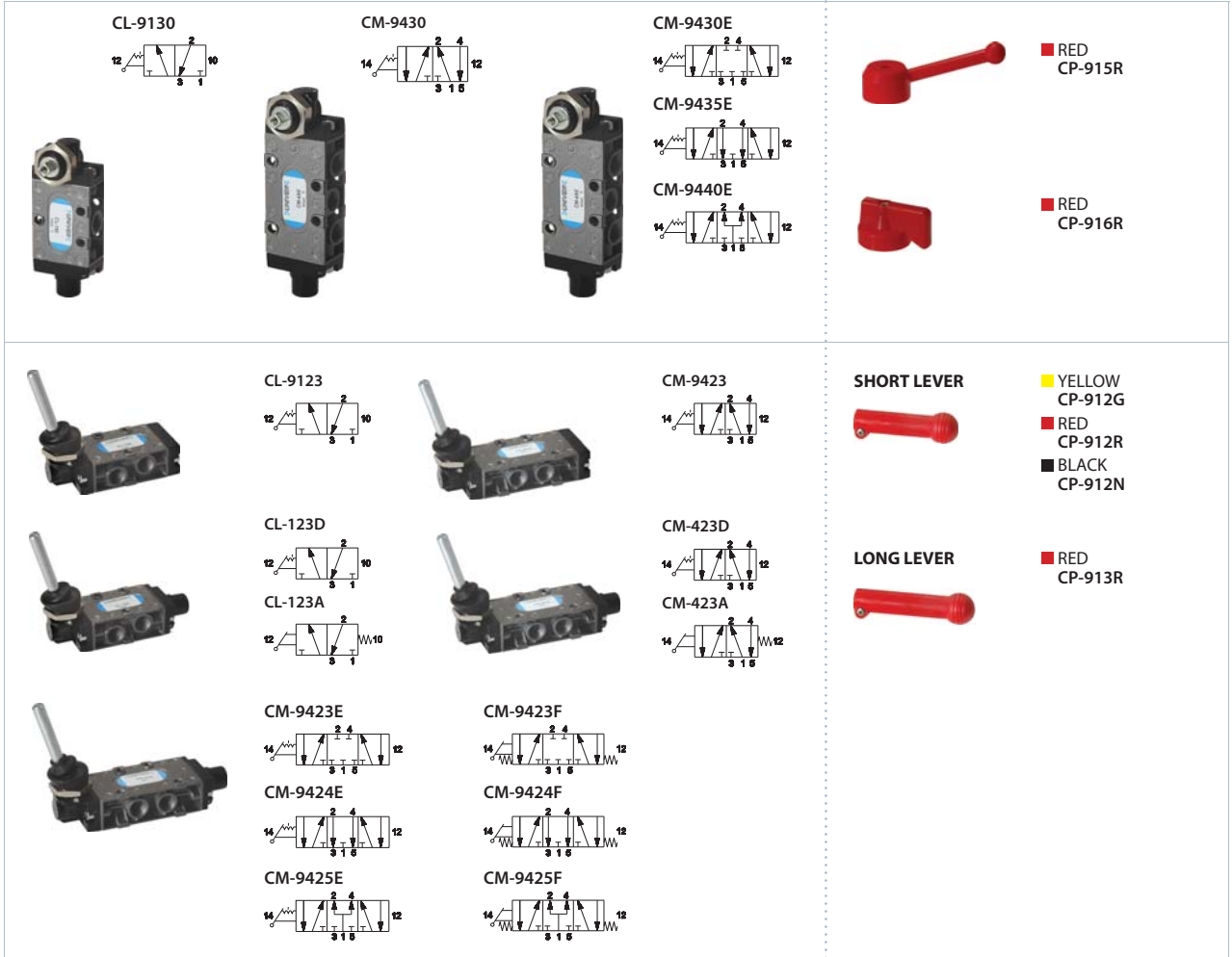

	Return	Flow rate (NI/min)	Ø mm	Weight Kg	Force N	Part no.	Composition (a)			Tot L. mm
							Control	Body	Return	
ROTATING LEVER (SELECTOR UPON REQUEST)										
3/2 NC-NO	rotating lever	1480	8,5	0,25	29	CL-9130	D	1	G	113
5/2	rotating lever	1490	8,5	0,27	29	CM-9430	D	2	G	130,5
5/3 c.c.	rotating lever	1480	8,5	0,27	29	CM-9430E	D	2	G	130,5
5/3 o.c.	rotating lever	1480	8,5	0,26	29	CM-9435E	D	2	G	130,5
5/3 p.c.	rotating lever	1480	8,5	0,26	29	CM-9440E	D	2	G	130,5
90° LEVER - 3 POSITION (b)										
3/2 NC-NO	lever	1480	8,5	0,23	2,7÷4,5	CL-9123	E	1	H	99,5
5/2	lever	1480	8,5	0,28	2,7÷4,5	CM-9423	E	2	H	117,5
3/2 NC-NO	lever	1480	8,5	0,23	3,6÷5,2	CL-9123D	E	1	G	110,5
5/2	lever	1480	8,5	0,28	3,6÷5,2	CM-9423D	E	2	G	128
3/2 NC-NO	mechanical spring	1480	8,5	0,24	10÷14	CL-9123A	E	1	F	110,5
5/2	mechanical spring	1480	8,5	0,28	10÷14	CM-9423A	E	2	F	128
5/3 c.c.	lever	1480	8,5	0,28	3,6÷5,2	CM-9423E	E	2	G	128
	lever	1480	8,5	0,28	6,7÷11	CM-9423F	E	2	G	128
5/3 o.c.	lever	1480	8,5	0,28	3,6÷5,2	CM-9424E	E	2	G	128
	lever	1480	8,5	0,28	6,7÷11	CM-9424F	E	2	G	128
5/3 p.c.	lever	1480	8,5	0,28	3,6÷5,2	CM-9425E	E	2	G	128
	lever	1480	8,5	0,28	6,7÷11	CM-9425F	E	2	G	128

o.c. = open centres c.c. = closed centres p.c. = pressurized centres

To get 3/2 NO version, supply the valve from port 3

(b) = valves are supplied without operator Pressure 0 ÷ 10 bar for all part numbers

(a) = see pages 3_18

Overall dimensions include operator

Composition

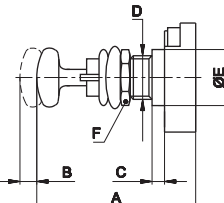
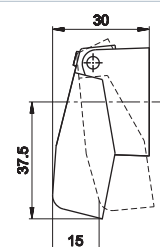
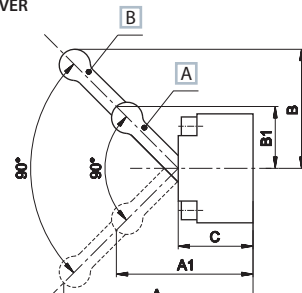
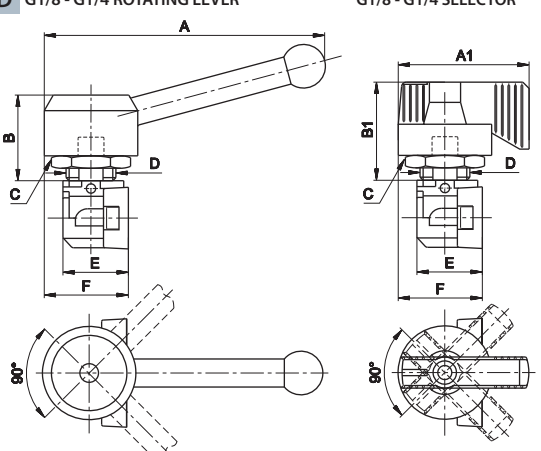
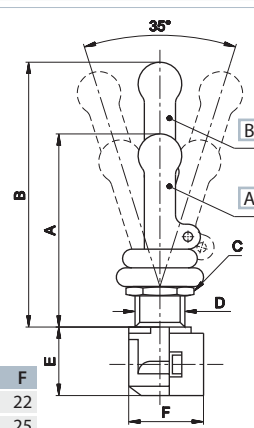
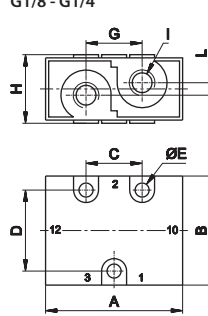
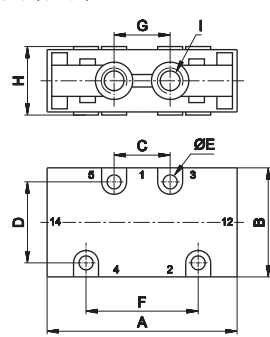
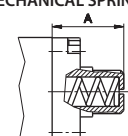
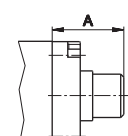
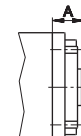
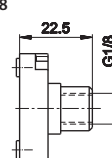
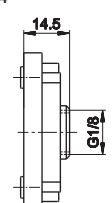
Control	Body	Return																														
<p>A G1/8 - G1/4 PUSH-PULL</p>  <table border="1" style="width:100%; border-collapse: collapse;"> <thead> <tr> <th></th> <th>A</th> <th>B</th> <th>C</th> <th>D</th> <th>E</th> <th>F</th> </tr> </thead> <tbody> <tr> <td>G1/8</td> <td>51</td> <td>5,4</td> <td>4</td> <td>M14x1</td> <td>16</td> <td>18</td> </tr> <tr> <td>G1/4</td> <td>52,5</td> <td>6</td> <td>2,5</td> <td>M16x1,5</td> <td>22</td> <td>22</td> </tr> </tbody> </table>		A	B	C	D	E	F	G1/8	51	5,4	4	M14x1	16	18	G1/4	52,5	6	2,5	M16x1,5	22	22											
	A	B	C	D	E	F																										
G1/8	51	5,4	4	M14x1	16	18																										
G1/4	52,5	6	2,5	M16x1,5	22	22																										
<p>B G1/8 BUTTON</p> 																																
<p>C G1/8 - G1/4 LONG/SHORT LEVER</p>  <p>A Short lever B Long lever</p> <table border="1" style="width:100%; border-collapse: collapse;"> <thead> <tr> <th></th> <th>A</th> <th>A1</th> <th>B</th> <th>B1</th> <th>C</th> <th>A</th> <th>B</th> <th>C</th> </tr> </thead> <tbody> <tr> <td>G1/8</td> <td>56</td> <td>42</td> <td>38,5</td> <td>24</td> <td>22,5</td> <td>G1/4</td> <td>58,5</td> <td>32</td> <td>26</td> </tr> </tbody> </table>		A	A1	B	B1	C	A	B	C	G1/8	56	42	38,5	24	22,5	G1/4	58,5	32	26													
	A	A1	B	B1	C	A	B	C																								
G1/8	56	42	38,5	24	22,5	G1/4	58,5	32	26																							
<p>D G1/8 - G1/4 ROTATING LEVER G1/8 - G1/4 SELECTOR</p>  <table border="1" style="width:100%; border-collapse: collapse;"> <thead> <tr> <th></th> <th>A</th> <th>A1</th> <th>B</th> <th>B1</th> <th>C</th> <th>D</th> <th>E</th> <th>F</th> </tr> </thead> <tbody> <tr> <td>G1/8</td> <td>89</td> <td>42</td> <td>32</td> <td>29</td> <td>22</td> <td>M16x1,5</td> <td>22</td> <td>27</td> </tr> <tr> <td>G1/4</td> <td>89</td> <td>42</td> <td>32</td> <td>29</td> <td>24</td> <td>M18x1,5</td> <td>25</td> <td>27,5</td> </tr> </tbody> </table>		A	A1	B	B1	C	D	E	F	G1/8	89	42	32	29	22	M16x1,5	22	27	G1/4	89	42	32	29	24	M18x1,5	25	27,5					
	A	A1	B	B1	C	D	E	F																								
G1/8	89	42	32	29	22	M16x1,5	22	27																								
G1/4	89	42	32	29	24	M18x1,5	25	27,5																								
<p>E G1/8 - G1/4 90° LEVER</p>  <p>A Short lever B Long lever</p> <table border="1" style="width:100%; border-collapse: collapse;"> <thead> <tr> <th></th> <th>A</th> <th>B</th> <th>C</th> <th>D</th> <th>E</th> <th>F</th> </tr> </thead> <tbody> <tr> <td>G1/8</td> <td>62</td> <td>85</td> <td>22</td> <td>M16x1,5</td> <td>21,5</td> <td>22</td> </tr> <tr> <td>G1/4</td> <td>90</td> <td>110</td> <td>24</td> <td>M18x1,5</td> <td>29</td> <td>25</td> </tr> </tbody> </table>		A	B	C	D	E	F	G1/8	62	85	22	M16x1,5	21,5	22	G1/4	90	110	24	M18x1,5	29	25											
	A	B	C	D	E	F																										
G1/8	62	85	22	M16x1,5	21,5	22																										
G1/4	90	110	24	M18x1,5	29	25																										
	<p>1 3/2 NC-NO G1/8 - G1/4</p>  <p>>> NC 1 = Supply port 2 = Use 3 = Exhaust 12 = Control 10 = Return</p> <p>>> NO 1 = Exhaust 2 = Use 3 = Supply port 12 = Control 10 = Return</p> <table border="1" style="width:100%; border-collapse: collapse;"> <thead> <tr> <th></th> <th>A</th> <th>B</th> <th>C</th> <th>D</th> <th>E</th> <th>G</th> <th>H</th> <th>I</th> <th>L</th> </tr> </thead> <tbody> <tr> <td>G1/8</td> <td>47,5</td> <td>35</td> <td>18</td> <td>26</td> <td>4,5</td> <td>18</td> <td>22</td> <td>G1/8</td> <td>4</td> </tr> <tr> <td>G1/4</td> <td>60</td> <td>48</td> <td>22</td> <td>38</td> <td>5,5</td> <td>22</td> <td>26</td> <td>G1/4</td> <td>4</td> </tr> </tbody> </table>		A	B	C	D	E	G	H	I	L	G1/8	47,5	35	18	26	4,5	18	22	G1/8	4	G1/4	60	48	22	38	5,5	22	26	G1/4	4	
	A	B	C	D	E	G	H	I	L																							
G1/8	47,5	35	18	26	4,5	18	22	G1/8	4																							
G1/4	60	48	22	38	5,5	22	26	G1/4	4																							
	<p>2 5/2 - 5/3 G1/8 - G1/4</p>  <p>1 = Supply port 2 - 4 = Use 3 - 5 = Exhaust 14 = Control 12 = Return</p> <table border="1" style="width:100%; border-collapse: collapse;"> <thead> <tr> <th></th> <th>A</th> <th>B</th> <th>C</th> <th>D</th> <th>E</th> <th>F</th> <th>G</th> <th>H</th> <th>I</th> </tr> </thead> <tbody> <tr> <td>G1/8</td> <td>64</td> <td>35</td> <td>18</td> <td>26</td> <td>4,5</td> <td>36</td> <td>18</td> <td>22</td> <td>G1/8</td> </tr> <tr> <td>G1/4</td> <td>77,5</td> <td>48</td> <td>22</td> <td>38</td> <td>5,5</td> <td>48</td> <td>22</td> <td>26</td> <td>G1/4</td> </tr> </tbody> </table>		A	B	C	D	E	F	G	H	I	G1/8	64	35	18	26	4,5	36	18	22	G1/8	G1/4	77,5	48	22	38	5,5	48	22	26	G1/4	
	A	B	C	D	E	F	G	H	I																							
G1/8	64	35	18	26	4,5	36	18	22	G1/8																							
G1/4	77,5	48	22	38	5,5	48	22	26	G1/4																							
		<p>F G1/8 - G1/4 MECHANICAL SPRING</p>  <table border="1" style="width:100%; border-collapse: collapse;"> <thead> <tr> <th></th> <th>A</th> </tr> </thead> <tbody> <tr> <td>G1/8</td> <td>22,5</td> </tr> <tr> <td>G1/4</td> <td>25,5</td> </tr> </tbody> </table>		A	G1/8	22,5	G1/4	25,5																								
	A																															
G1/8	22,5																															
G1/4	25,5																															
		<p>G G1/8 - G1/4 2/3 POSITION</p>  <table border="1" style="width:100%; border-collapse: collapse;"> <thead> <tr> <th></th> <th>A</th> </tr> </thead> <tbody> <tr> <td>G1/8</td> <td>22,5</td> </tr> <tr> <td>G1/4</td> <td>25,5</td> </tr> </tbody> </table>		A	G1/8	22,5	G1/4	25,5																								
	A																															
G1/8	22,5																															
G1/4	25,5																															
		<p>H BOTTOM PLATE WITHOUT SPRING G1/8 - G1/4</p>  <table border="1" style="width:100%; border-collapse: collapse;"> <thead> <tr> <th></th> <th>A</th> </tr> </thead> <tbody> <tr> <td>G1/8</td> <td>10</td> </tr> <tr> <td>G1/4</td> <td>14,5</td> </tr> </tbody> </table>		A	G1/8	10	G1/4	14,5																								
	A																															
G1/8	10																															
G1/4	14,5																															
		<p>I G1/8 - G1/4 PNEUMATIC NOT AMPLIFIED</p> <p>>> G1/8</p>  <p>>> G1/4</p> 																														

G1/8 Valves with pneumatic control



	Control	Return	Pressure bar	Flow rate (NI/min)	Ø mm	Weight Kg	Times (ms)		Part no.	Composition (a)			Tot L. mm
							En.	De-en.		Control	Body	Return	
SINGLE IMPULSE													
3/2 NC	pneumatic amplified	pneumatic spring	2,3÷10	890	6,5	0,20	11	14	CL-200	B	1	E	82,5
3/2 NO	pneumatic amplified	pneumatic spring	2,3÷10	890	6,5	0,20	11	14	CL-203	B	1	E	82,5
3/2 NC-NO	pneumatic amplified	mechanical spring	2,5÷10	890	6,5	0,21	9	17	CL-200A	B	1	D	95
5/2	pneumatic amplified	pneumatic spring	2,5÷10	890	6,5	0,20	10	15	CM-500	B	2	E	99
	pneumatic amplified	mechanical spring	3÷10	890	6,5	0,19	10	18	CM-500A	B	2	D	111,5
DOUBLE IMPULSE													
3/2 NC-NO	pneumatic amplified	pneumatic amplified	1÷10	890	6,5	0,16	6	6	CL-220	B	1	F	97,5
	pneumatic amplified	pneumatic not amplified	1,7÷10	890	6,5	0,15	6	8	CL-221	B	1	G	95
	pneumatic non amplified	pneumatic not amplified	1,7÷10	890	6,5	0,14	8	8	CL-224	C	1	G	92,5
5/2	pneumatic amplified	pneumatic amplified	1,2÷10	890	6,5	0,18	7	7	CM-520	B	2	F	114
	pneumatic amplified	pneumatic not amplified	2÷10	890	6,5	0,19	7	9	CM-521	B	2	G	111,5
	pneumatic non amplified	pneumatic not amplified	2÷10	890	6,5	0,20	9	9	CM-524	C	2	G	109
5/3 c.c.	pneumatic amplified	pneumatic amplified	2,5÷10	890	6,5	0,21	8	12	CM-580	B	2	F	114
5/3 o.c.	pneumatic amplified	pneumatic amplified	2,5÷10	890	6,5	0,21	8	12	CM-585	B	2	F	114
5/3 p.c.	pneumatic amplified	pneumatic amplified	2,5÷10	890	6,5	0,21	8	12	CM-590	B	2	F	114

o.c. = open centres c.c. = closed centres p.c. = pressurized centres
To get 3/2 NO version, supply the valve from port 3

(a) = see page 3_23

G1/4 Valves with pneumatic control



	Control	Return	Pressure bar	Flow rate (NI/min)	Ø mm	Weight Kg	Times (ms)		Part no.	Composition (a)			Tot L. mm
							En.	De-en.		Control	Body	Return	
SINGLE IMPULSE													
3/2 NC	pneumatic amplified	pneumatic spring	2÷10	1480	8,5	0,23	13	16	CL-9200	B	1	E	103
3/2 NO	pneumatic amplified	pneumatic spring	2÷10	1480	8,5	0,23	13	16	CL-9203	B	1	E	103
3/2 NC-NO	pneumatic amplified	mechanical spring	2÷10	1480	8,5	0,24	10	19	CL-9200A	B	1	D	114
5/2	pneumatic amplified	pneumatic spring	2÷10	1480	8,5	0,26	13	16	CM-9500	B	2	E	120,5
	pneumatic amplified	mechanical spring	2÷10	1480	8,5	0,17	11	20	CM-9500A	B	2	D	131,5
DOUBLE													
3/2 NC-NO	pneumatic amplified	pneumatic amplified	1÷10	1480	8,5	0,21	8	8	CL-9220	B	1	F	117
	pneumatic amplified	pneumatic not amplified	1,5÷10	1480	8,5	0,22	8	10	CL-9221	B	1	G	103
	pneumatic not amplified	pneumatic not amplified	1,5÷10	1480	8,5	0,24	10	10	CL-9224	C	1	G	89
5/2	pneumatic amplified	pneumatic amplified	1,5÷10	1480	8,5	0,24	9	9	CM-9520	B	2	F	134,5
	pneumatic amplified	pneumatic not amplified	1,8÷10	1480	8,5	0,25	9	10	CM-9521	B	2	G	120,5
	pneumatic not amplified	pneumatic not amplified	1,8÷10	1480	8,5	0,27	10	10	CM-9524	C	2	G	198,5
5/3 c.c.	pneumatic amplified	pneumatic amplified	2,8÷10	1480	8,5	0,30	10	13	CM-9580	B	2	F	134,5
5/3 o.c.	pneumatic amplified	pneumatic amplified	2,8÷10	1480	8,5	0,30	10	13	CM-9585	B	2	F	134,5
5/3 p.c.	pneumatic amplified	pneumatic amplified	1,8÷10	1480	8,5	0,30	10	13	CM-9590	B	2	F	134,5

o.c. = open centres c.c. = closed centres p.c. = pressurized centres
To get 3/2 NO version, supply the valve from port 3

(a) = see page 3_23

G1/8 Valves with electric control

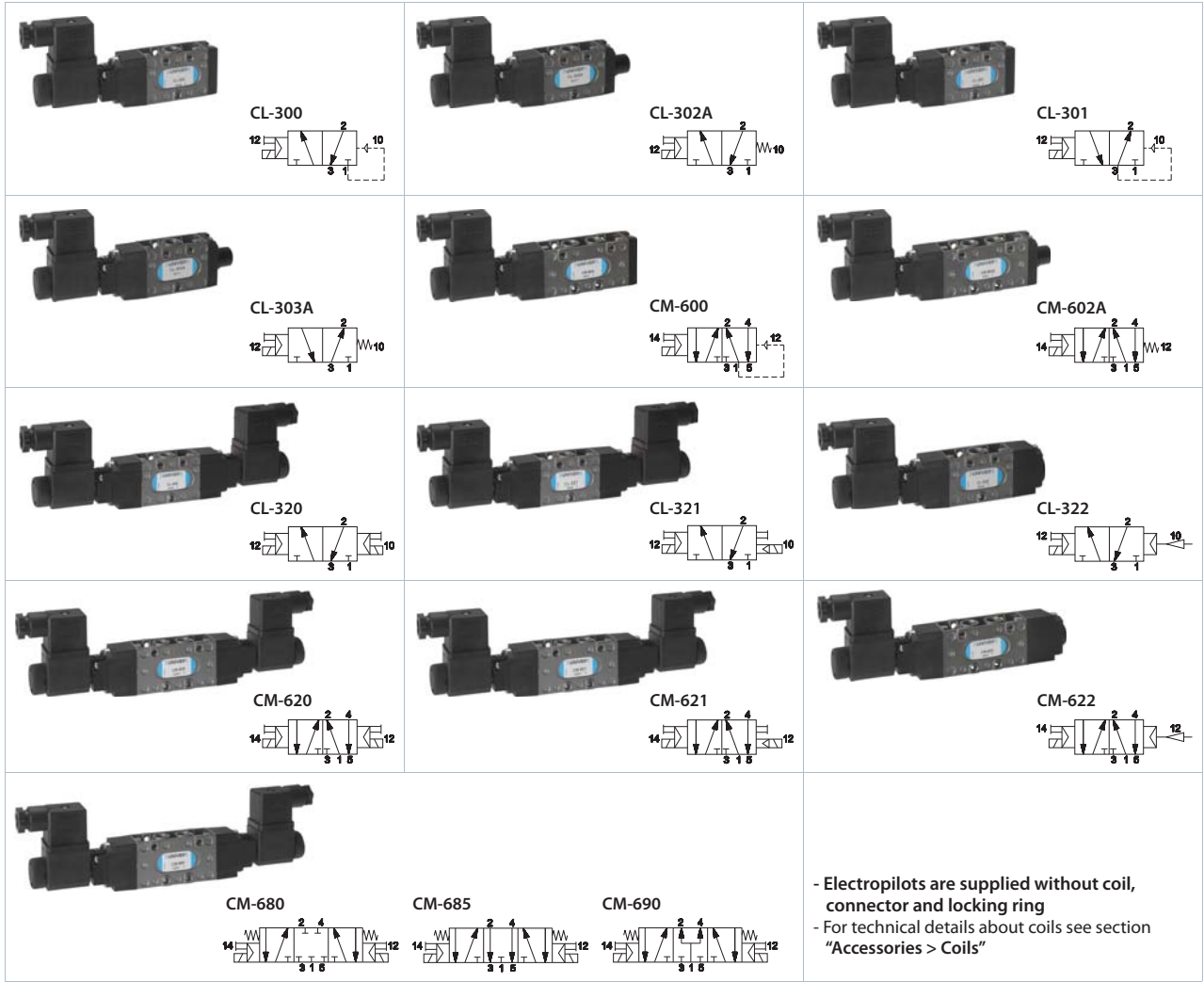

- Electropilots are supplied without coil, connector and locking ring
 - For technical details about coils see section "Accessories > Coils"

	Control	Return	Pressure bar	Flow rate (Nl/min)	Ø mm	Weight Kg	Times (ms)		Part no.	Composition (a)			Tot L. mm
							En.	De-en.		Control	Body	Return	
SINGLE IMPULSE													
3/2 NC	electrical amplified	pneumatic spring	2,3÷10	890	6,5	0,20	23	19	CL-300	A	1	E	140,5
	electrical amplified	mechanical spring	2,5÷10	890	6,5	0,21	20	24	CL-302A	A	1	D	153
3/2 NO	electrical amplified	pneumatic spring	2,3÷10	890	6,5	0,20	23	19	CL-301	A	1	E	140,5
	electrical amplified	mechanical spring	2,5÷10	890	6,5	0,21	20	24	CL-303A	A	1	D	153
5/2	electrical amplified	pneumatic spring	2,5÷10	890	6,5	0,24	24	20	CM-600	A	2	E	157
	electrical amplified	mechanical spring	3÷10	890	6,5	0,25	21	25	CM-602A	A	2	D	169,5
DOUBLE IMPULSE													
3/2 NC-NO	electrical amplified	electrical amplified	1÷10	890	6,5	0,24	17	17	CL-320	A	1	H	213,5
	electrical amplified	electrical not amplified	1,7÷10	890	6,5	0,24	17	20	CL-321	A	1	H	213,5
	electrical amplified	pneumatic amplified	2,5÷10	890	6,5	0,21	20	7	CL-322	A	1	F	155,5
5/2	electrical amplified	electrical amplified	1,2÷10	890	6,5	0,28	20	20	CM-620	A	2	H	230
	electrical amplified	electrical not amplified	2÷10	890	6,5	0,28	20	23	CM-621	A	2	H	230
	electrical amplified	pneumatic amplified	1,2÷10	890	6,5	0,24	20	8	CM-622	A	2	F	172
5/3 c.c.	electrical amplified	electrical amplified	2,5÷10	890	6,5	0,21	18	24	CM-680	A	2	H	230
5/3 o.c.	electrical amplified	electrical amplified	2,5÷10	890	6,5	0,21	18	24	CM-685	A	2	H	230
5/3 p.c.	electrical amplified	electrical amplified	2,5÷10	890	6,5	0,21	18	24	CM-690	A	2	H	230

o.c. = open centres c.c. = closed centres p.c. = pressurized centres
 To get 3/2 NO version, supply the valve from port 3

(a) = see page 3_23

G1/4 Valves with electric control

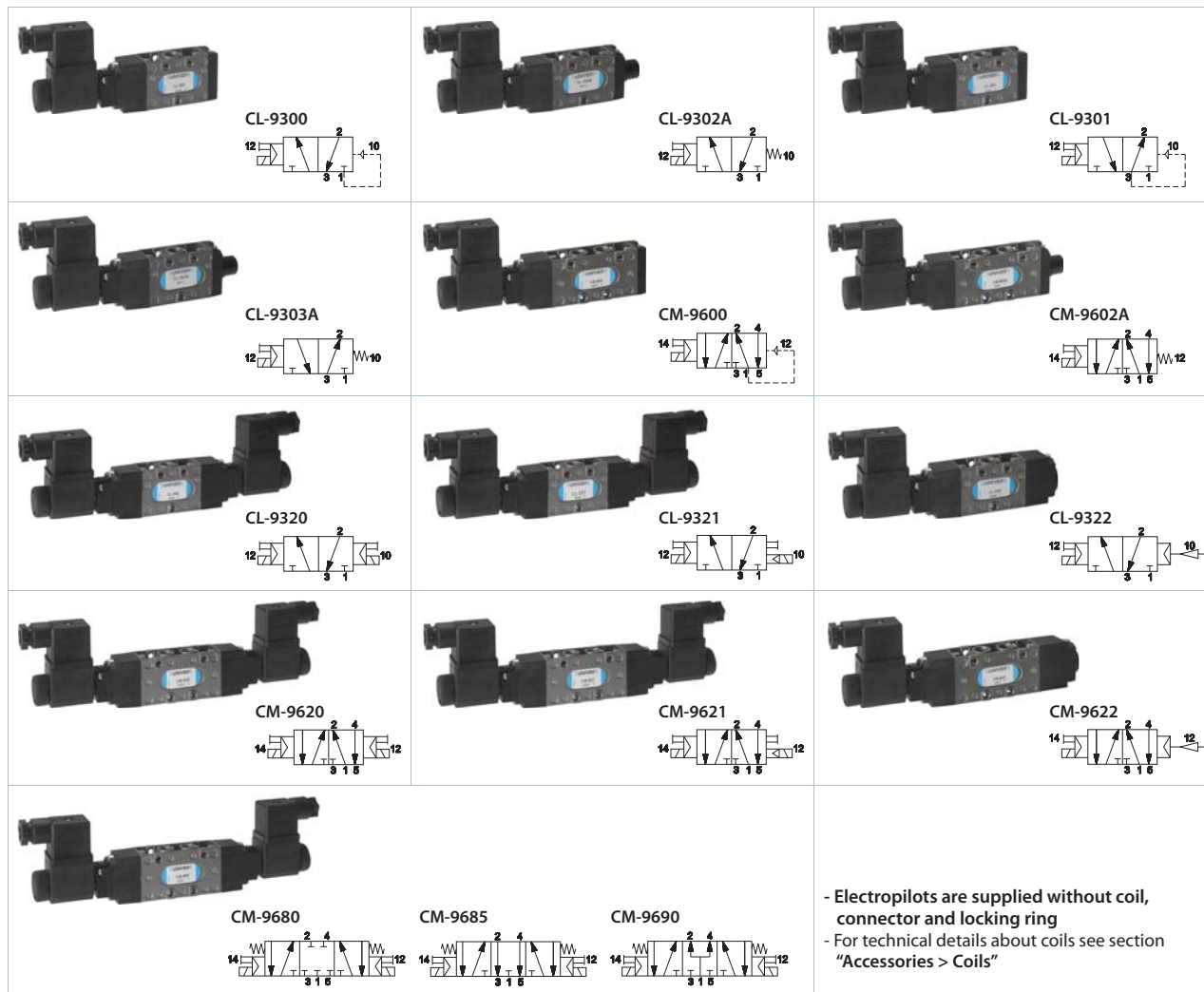

- Electropilots are supplied without coil, connector and locking ring
 - For technical details about coils see section "Accessories > Coils"

	Control	Return	Pressione bar	Portata (NI/min)	Ø mm	Weight Kg	Times (ms)		Part no.	Composition (a)			Tot L. mm	
							En.	De-en.		Control	Body	Return		
3/2 NC	electrical amplified	pneumatic spring	2÷10	1480	8,5	0,27	24	28	CL-9300	A	1	E	161	
	electrical amplified	mechanical spring	2÷10	1480	8,5	0,28	22	35	CL-9302A	A	1	D	172	
	3/2 NO	electrical amplified	pneumatic spring	2÷10	1480	8,5	0,27	24	28	CL-9301	A	1	E	161
		electrical amplified	mechanical spring	2÷10	1480	8,5	0,28	22	35	CL-9303A	A	1	D	172
	5/2	electrical amplified	pneumatic spring	2÷10	1480	8,5	0,30	25	32	CM-9600	A	2	E	178,5
		electrical amplified	mechanical spring	2÷10	1480	8,5	0,31	22	43	CM-9602A	A	2	D	189,5
3/2 NC_NO	electrical amplified	electrical amplified	2÷10	1480	8,5	0,29	18	18	CL-9320	A	1	H	233	
	electrical amplified	elettrico not amplified	1,5÷10	1480	8,5	0,30	18	22	CL-9321	A	1	H	233	
	electrical amplified	pneumatic amplified	2÷10	1480	8,5	0,26	22	8	CL-9322	A	1	F	175	
	5/2	electrical amplified	electrical amplified	1,5÷10	1480	8,5	0,32	22	22	CM-9620	A	2	H	250,5
		electrical amplified	elettrico not amplified	1,8÷10	1480	8,5	0,32	22	25	CM-9621	A	2	H	250,5
		electrical amplified	pneumatic amplified	1,5÷10	1480	8,5	0,29	22	10	CM-9622	A	2	F	192,5
5/3 c.c.	electrical amplified	electrical amplified	2,8÷10	1480	6,5	0,30	20	35	CM-9680	A	2	H	250,5	
5/3 o.c.	electrical amplified	electrical amplified	2,8÷10	1480	6,5	0,30	20	35	CM-9685	A	2	H	250,5	
5/3 p.c.	electrical amplified	electrical amplified	2,8÷10	1480	6,5	0,30	20	35	CM-9690	A	2	H	250,5	

o.c. = open centres c.c. = closed centres p.c. = pressurized centres
 To get 3/2 NO version, supply the valve from port 3

(a) = see pages 3_23

Composition

Control

Body

Return

A G1/8 - G1/4 ELECTRIC/AMPLIFIED

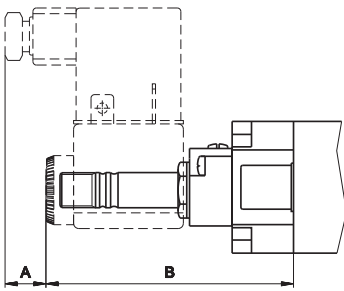

	A	B
G1/8	10	77
G1/4	10	80

B G1/8 - G1/4 PNEUMATIC AMPLIFIED

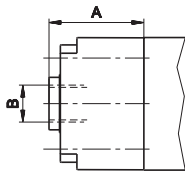

	A	B
G1/8	25	G1/8
G1/4	28,5	G1/8

C G1/8 - G1/4 PNEUMATIC NOT AMPLIFIED

>> G1/8

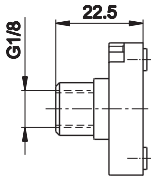

>> G1/4

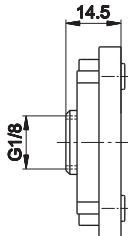

1 3/2 NC-NO G1/8 - G1/4

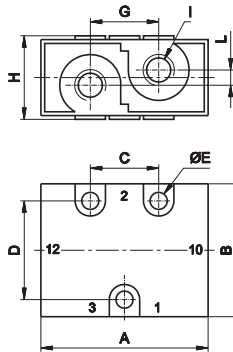

- >> NC
- 1 = Supply port
- 2 = Use
- 3 = Exhaust
- 12 = Control
- 10 = Return
- >> NO
- 1 = Exhaust
- 2 = Use
- 3 = Supply port
- 12 = Control
- 10 = Return

	A	B	C	D	E	G	H	I	L
G1/8	47,5	35	18	26	4,5	18	22	G1/8	4
G1/4	60	48	22	38	5,5	22	26	G1/4	4

2 5/2 G1/8 - G1/4

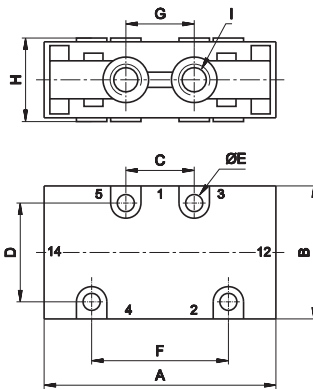

- 1 = Supply port
- 2 - 4 = Use
- 3 - 5 = Exhaust
- 14 = Control
- 12 = Return

	A	B	C	D	E	F	G	H	I
G1/8	64	35	18	26	4,5	36	18	22	G1/8
G1/4	77,5	48	22	38	5,5	48	22	26	G1/4

D G1/8 - G1/4 MECHANICAL SPRING

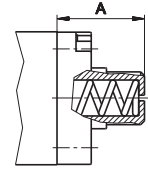

	A
G1/8	22,5
G1/4	25,5

E G1/8 - G1/4 PNEUMATIC SPRING

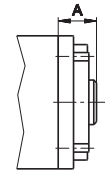

	A
G1/8	10
G1/4	14,5

F G1/8 - G1/4 PNEUMATIC AMPLIFIED

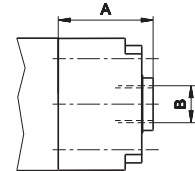

	A	B
G1/8	25	G1/8
G1/4	28,5	G1/8

G G1/8 - G1/4 PNEUMATIC NOT AMPLIFIED

>> G1/8

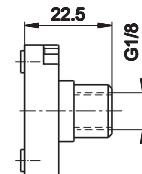

>> G1/4

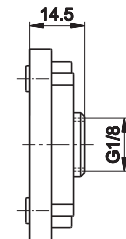

H G1/8 - G1/4 ELECTRIC AMPLIFIED

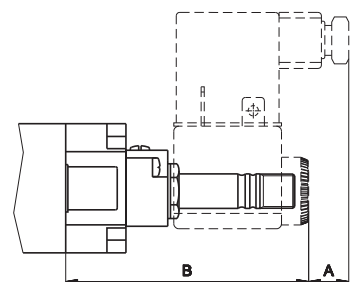

	A	B
G1/8	10	73
G1/4	10	76,5

AM-5148

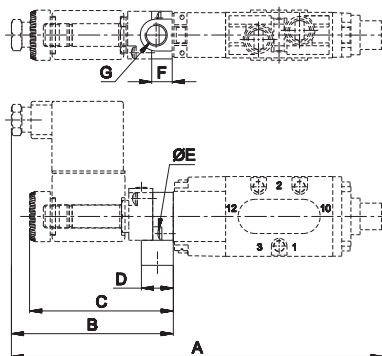
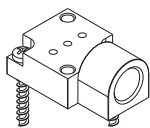

	G1/8	G1/4
A	163	175,5
B	71	71
C	63	63
D	14	14
E	2,9x10	2,9x10
F	9	9
G	G1/8	G1/8

Plate for external servoassistance
weight: 0,03 Kg

AM-5151

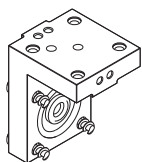

AM-5151 + AM-5148

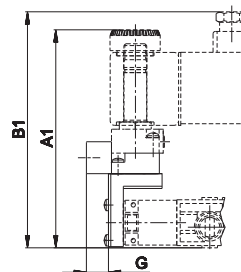
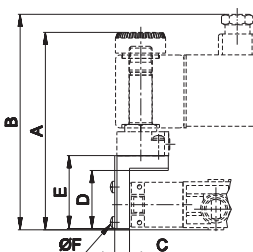

	G1/8	G1/4
A	86,7	88,7
A1	95,7	97,7
B	94,5	96,5
B1	103,5	105,5
C	6,5	6,5
D	25,5	25,5
E	32	32
F	2,9x10	2,9x10
G	9,7	9,7

"H" option angle plate
weight: 0,035 Kg

AM-5152

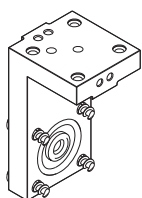

AM-5152 + AM-5148

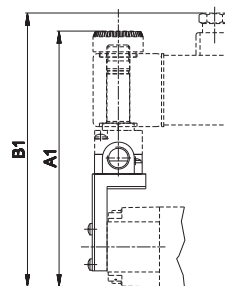
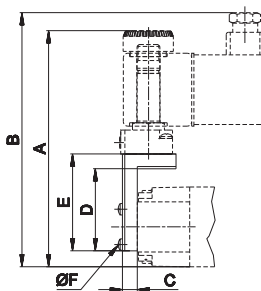

	G1/8	G1/4
A	103,5	110
A1	112,2	118,7
B	111,5	118
B1	120	126,5
C	6,5	6,5
D	36	36
E	42,5	42,5
F	2,9x10	2,9x10

"P" option angle plate
weight: 0,05 Kg

G1/8 Modular subbase "CLIPS" for 3/2 - 5/2 - 5/3 valves

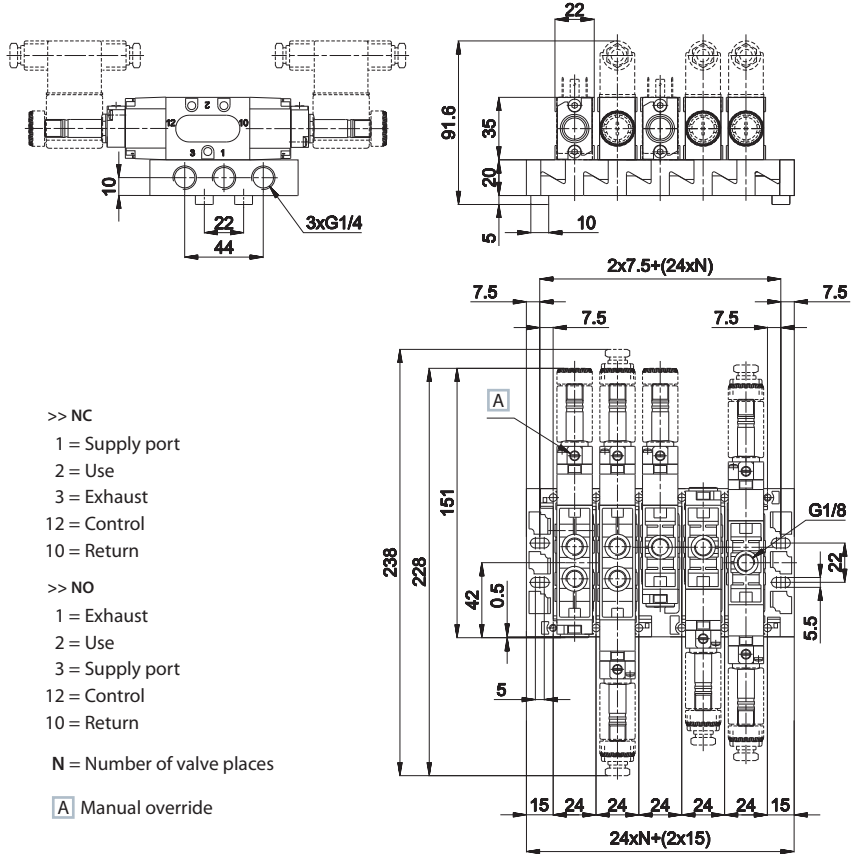

- >> NC
 - 1 = Supply port
 - 2 = Use
 - 3 = Exhaust
 - 12 = Control
 - 10 = Return
- >> NO
 - 1 = Exhaust
 - 2 = Use
 - 3 = Supply port
 - 12 = Control
 - 10 = Return
- N = Number of valve places
- A** Manual override

When assembling the manifold put the sub-base on a flat surface and tighten the special screw supplied. This will give perfect alignment.

CP-100	CP-101	CP-105
	NEW	
modular sub-base with regulated and conveyed exhausts connections: G1/8 material: zamak weight: 0,136 Kg	modular sub-base without exhaust regulator connections: G1/8 material: zamak weight: 0,136 Kg	inlet plate side connections connections: G1/4 material: zamak weight: 0,086 Kg
standard supplied: screws, seals, exhausts regulator and fixing coupling	standard supplied: screws, seals and fixing coupling of valve	standard supplied: screws and seals

CP-110	CP-111	CP-112	CP-113
coupling connections: G1/8 material: brass weight: 0,028 Kg	separatore pressioni differenziali connessione: G1/8 materiale: alluminio peso: 0,013 Kg	cap for 3/2 valve mounting connections: G1/8 material: alluminio weight: 0,010 Kg	adjustment screw connections: G1/8 material: brass weight: 0,006 Kg
For each additional pressure, one coupling and two separators must be ordered.		Cap for mounting of 3/2 NC-NO valves on "CLIPS" sub-base to close non-used way. Standard sub-base with adjustment screw. The screw head has a slot for screwdrivers. Upon request: adjustment screw with	

G1/4 Modular subbase "CLIPS" for 3/2 - 5/2 - 5/3 valves

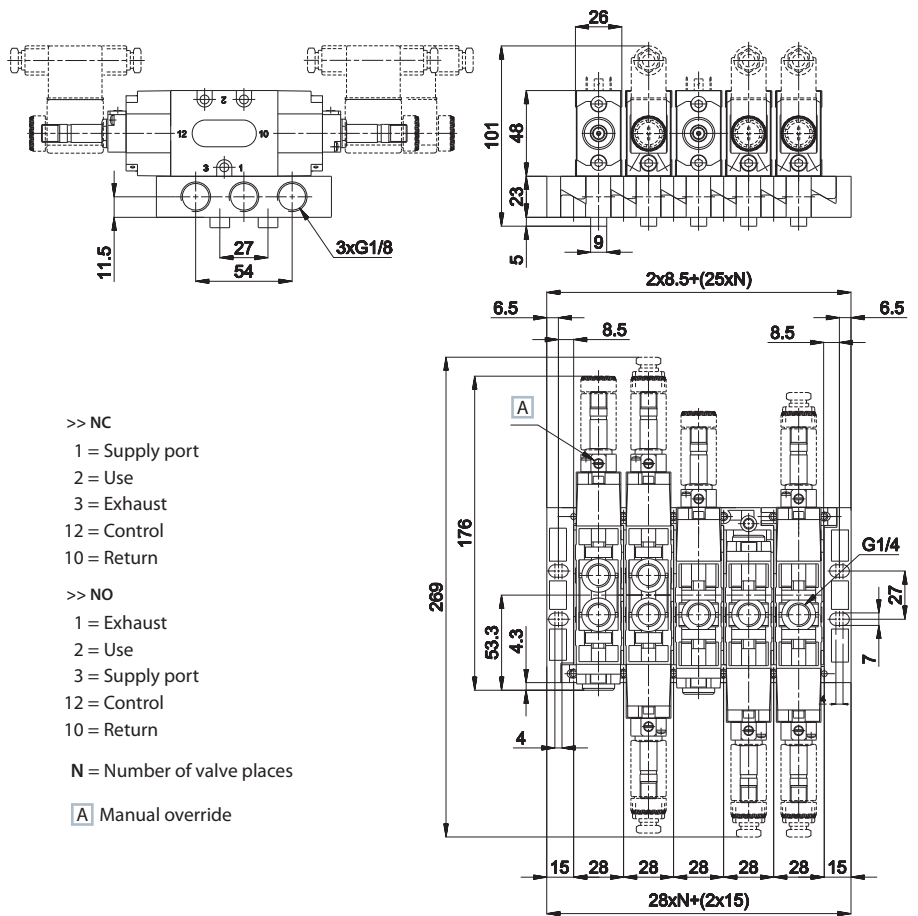

- >> NC
 - 1 = Supply port
 - 2 = Use
 - 3 = Exhaust
 - 12 = Control
 - 10 = Return
- >> NO
 - 1 = Exhaust
 - 2 = Use
 - 3 = Supply port
 - 12 = Control
 - 10 = Return
- N = Number of valve places
- A** Manual override

When assembling the manifold put the sub-base on a flat surface and tighten the special screw supplied. This will give perfect alignment.

CP-9100	CP-9101	CP-9105
	N E W	
modular sub-base regulated and conveyed exhausts connections: G1/4 material: zamak weight: 0,210 Kg	modular sub-base without exhaust regulator connections: G1/4 material: zamak weight: 0,210 Kg	inlet plate side connections connections: G3/8 material: zamak weight: 0,120 Kg
standard supplied: screws, seals, exhaust regulator and fixing coupling	standard supplied: screws, seals and fixing coupling of valve	standard supplied: screws and seals

CP-9110	CP-9111	CP-9112	CP-9113
coupling connections: G1/4 material: brass weight: 0,028 Kg	separator of differential pressure connections: G1/4 material: aluminium weight: 0,013 Kg	cap for 3/2 valve mounting connections: G1/4 material: aluminium weight: 0,010 Kg	adjustment screw connections: G1/4 material: ottone weight: 0,006 Kg
For each additional pressure, one coupling and two separators must be ordered.		Cap for mounting of 3/2 NC-NO valves on "CLIPS" sub-base to close non-used way. Standard sub-base with adjustment screw. The screw head has a slot for screwdrivers. Upon request: adjustment screw with	

Assembly examples

Manifold 3 pressures

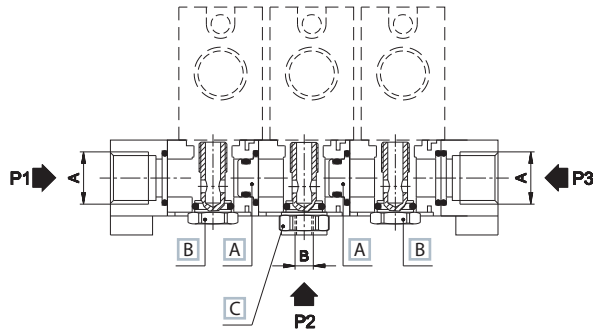

	A	B
G1/8	G1/4	G1/8
G1/4	G3/8	G1/4

- A Separator of differential pressures CP-111/CP-9111
- B Fixing coupling for valve inside the sub-base
- C Coupling CP-110/CP-9110

Mounting of 3/2 NC valve

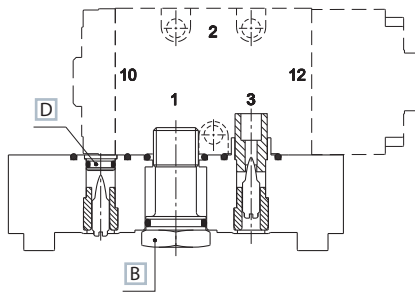

Mounting of 3/2 NO valve

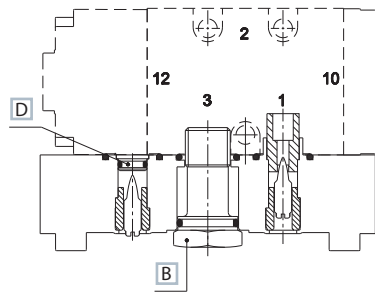

- B Fixing coupling for valve inside the sub-base
- D Cap for valve mounting CP-112/CP-9112

- | | |
|-----------------|-----------------|
| >> NC | >> NO |
| 1 = Supply port | 1 = Exhaust |
| 2 = Use | 2 = Use |
| 3 = Exhaust | 3 = Supply port |
| 12 = Control | 12 = Control |
| 10 = Return | 10 = Return |

In case there should be no need to regulate exhaust, plastic insert has to be removed whilst the adjustment screw must remain in its place.

